

**THE A B C OF
VACUUM TUBES
IN
RADIO RECEPTION**

E.H. LEWIS

TK 6550

L45



TK 6550

L45

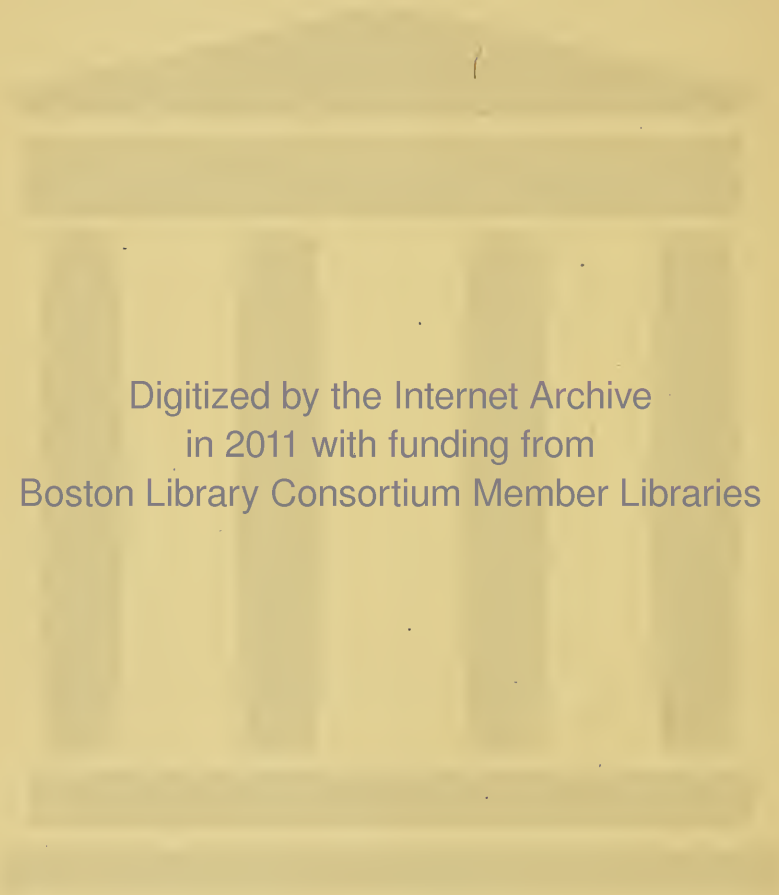

Digitized by the Internet Archive
in 2011 with funding from
Boston Library Consortium Member Libraries

THE A B C OF VACUUM TUBES IN RADIO RECEPTION

AN ELEMENTARY AND PRACTICAL BOOK ON THE
THEORY AND OPERATION OF VACUUM TUBES
AS DETECTORS AND AMPLIFIERS. EXPLAINS
NON-MATHEMATICALLY THE FUNDA-
MENTAL PRINCIPLES UPON WHICH
ALL VACUUM TUBE CIRCUITS
ARE BASED

INCLUDES

PRACTICAL CIRCUITS AND PRACTICAL QUESTIONS
AND ANSWERS. IT IS WRITTEN ESPECIALLY
FOR THE BEGINNER. ALL ELECTRICAL AND
RADIO TERMS ARE FULLY EXPLAINED

BY

E. H. LEWIS

Assoc. I.R.E., Radio Instructor,
East Side Y. M. C. A., New York City.



FULLY ILLUSTRATED

NEW YORK

THE NORMAN W. HENLEY PUBLISHING CO.

2 WEST 45TH STREET

1922

COPYRIGHTED, 1922

BY

THE NORMAN W. HENLEY PUBLISHING Co.

142757 ✓

PRINTED IN U. S. A.



PREFACE

The inauguration of radio-telephone broadcasting has quickly aroused an enormous general interest in radio reception of speech and music. The possibilities of this new method of broadcasting information of general interest and entertainment can hardly be estimated. The method is revolutionary and has been aptly compared to the invention of the printing press in this respect.

Vacuum tubes make possible the reception of radio-telephone speech and music and radio-telegraph signals with a degree of satisfaction not approached by prior devices.

The vacuum tube appears to the layman as a complicated form of incandescent electric lamp which operates in a very mysterious manner. In writing this little book the author has endeavored to overcome this impression and to clearly set forth the elementary principles of theory and operation. It is assumed that the reader has no knowledge of radio and very little, if any, of electricity. Mathematics has been especially avoided in the treatment of the subject and no technical terms are used without their meaning being made clear.

The functioning of the "lamps" is fascinating to a great many people and the author hopes that the desire for elementary information regarding it will be fulfilled in the text. No attempt has been made to set forth all the possible circuit arrangements but those shown may serve as suggestions to experimenters who desire to evolve their own circuits. The practical questions and answers, it is hoped, may be of value to those who are contemplating the installation of receiving

PREFACE

equipment or who are getting unsatisfactory results because of insufficient information.

Suggestions regarding improvement of the material presented and the manner of presentation will be gratefully received from readers.

April, 1922.

THE AUTHOR.

CONTENTS

PAGE

CHAPTER I

Introductory

Electric current—Electrical pressure or Electromotive force—Resistance—Direct current—Alternating current—Frequency—Inductance—Capacitance—Resonance—Oscillations—The Reception of signals—Wave length—Tuning the receiving antenna—The Antenna as a complete circuit 15

CHAPTER II

The Vacuum Tube as a Rectifier and Relay Without Moving Parts

Tube construction—The Edison Effect—Electron emission from a heated filament—Dependence of plate current upon plate potential—Dependence of plate current upon filament current—Effect of grid potential upon plate current—Relay action—Rectification 38

CHAPTER III

The Vacuum Tube Detector

The telephone receiver—Simple detection—Detection with grid condenser—Effect of gas in a detector tube—Heterodyne action or the production of beats 59

CHAPTER IV

The Vacuum Tube Amplifier

General characteristics—Audio frequency amplification—Radio frequency amplification—Radio frequency regenerative amplification—Autodyne production of beats 76

CHAPTER V

Practical Circuits and Their Operation

Methods of coupling—The variometer—Inter electrode tube capacitance—Wave length, Frequency and Resonance—Circuits and explanations of their arrangement and operation 90

CONTENTS

CHAPTER VI

Voice Distortion

	PAGE
Amplifier transformers—Normal grid potential—Too great regeneration—Telephone receiver	111

CHAPTER VII



Practical Questions and Answers

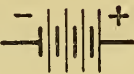

Practical Questions and Answers	116
---	-----

~ LIST OF SYMBOLS ~

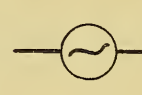
Battery ----- 



Direct Current Dynamo ---  or 

Alternating Current Generator } -----  or 

Fixed Capacitance (Condenser) -----  or 

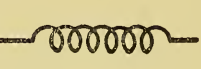
Variable Capacitance (Var. Condenser) ----- 

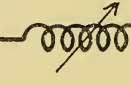
Fixed Inductance (Air Core Coil) ----- 

Variable Inductance (Air Core Coil) -----  or 

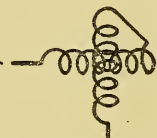
Variometer (Variable Inductance) --- 

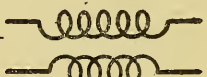
Fixed Coupling of Coils (Fixed Inductive Coupling) ----- 

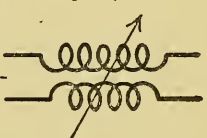
Variable Coupling of Coils ----- 

Transformer ----- 

Iron Core Inductance (or Reactance Coil) ----- 

~ LIST OF SYMBOLS ~

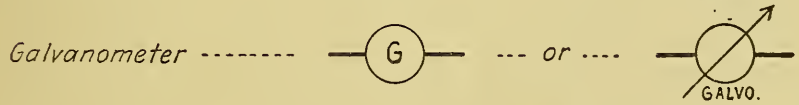
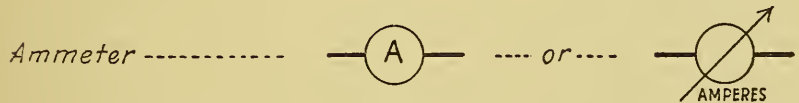
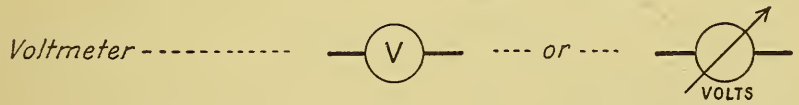
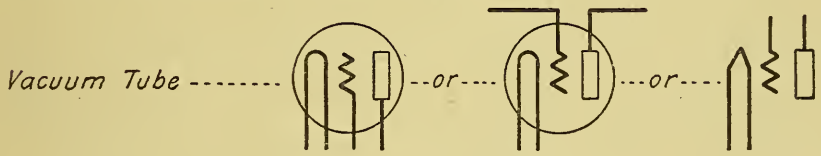
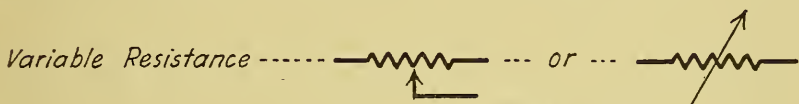
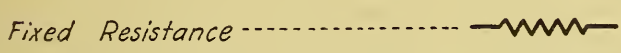
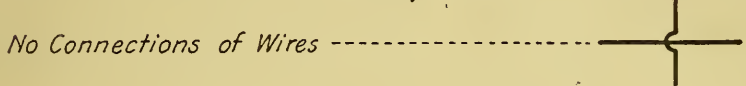
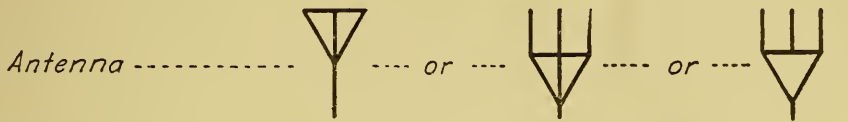

CHAPTER I

INTRODUCTORY

Electric current—Electrical pressure or Electromotive force—Resistance—Direct current—Alternating current—Frequency—Inductance—Capacitance—Resonance—Oscillations—The reception of signals—Wave length—Tuning the receiving antenna—The antenna as a complete circuit.

Before taking up the subject of vacuum tubes a brief outline of the most common electrical and radio phenomena together with the explanation of common electrical terms will be given. It is understood that for some this may be a review of knowledge previously gained. For others it may, however, serve to fix some very vague understandings and some familiarity with these fundamental facts is necessary in order to comprehend that which follows.

Electrical Current

It is very commonly known that a battery and a dynamo furnish what is called a "current of electricity" and that the electrical current will not flow unless a path is provided for it. The path is called the "electrical circuit" or simply the "circuit." For example, if it is desired to ring a door-bell it is necessary to connect the bell to a battery by means of insulated wires and if the path, or circuit, is broken at any point the bell will not ring. A push button may be used to keep the circuit broken until the button is pressed, whereupon an electric current flows through the circuit and the bell rings.

Fig. 1 represents such a circuit which may be closed at will by pushing the button. Since no electricity flows when the circuit is open we may assume that it flows in all parts of the circuit when it is closed. Thus, if the current flows from the battery at "A" it must return to the battery at "B." The terminal of the battery from which the current flows is called

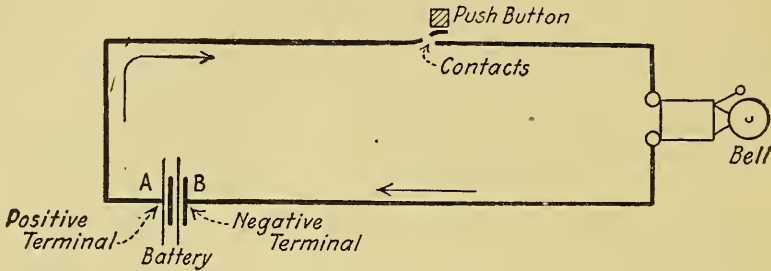

Fig. 1—Simple electrical path or circuit.

the "positive terminal and the other the "negative" terminal.

To illustrate the flow of current, a closed circuit of pipe may be used. A pump is located at "A" in Fig. 2 and the



Fig. 2—Water analogy of simple electrical circuit.

pipe is considered to be full of water. When the pump is operated the water will be forced to flow, let us say, in the direction of the arrow. It flows from the pump through the pipe and returns to the pump and the same amount of water which leaves the pump in one second of time will return to

it in the same length of time. In other words, there is a continuous flow of water until the pump stops. This corresponds to the electrical circuit and it may very easily be proven that the current is no stronger in one part than it is in any other part of the circuit.

We may measure the current or rate of flow of the water in gallons per second. That is, if there is one gallon flowing in one second past any given point in the pipe the rate of flow is one gallon per second. The current or rate of flow of electricity also may be measured and the unit is called the "ampere." The rate of flow of electric current is sometimes referred to as its "strength" and if the current strength is one ampere its rate of flow is one ampere, a certain fixed quantity of electricity per second.

It must not be assumed that electricity is actually a fluid like water. It is not. No one knows just what electricity is but its effects may be noted and its "flow" may be compared in many respects to that of water.

Electrical Pressure or Electro-Motive Force

Electrical pressure is referred to as "electro-motive force" since in order to create a current of electricity it is necessary to provide some force to make it flow. In the case of the pipe full of water the pump must exert a force or pressure upon the water to push it through the pipe. In the case of the electrical circuit in Fig. 1 the battery furnishes the electrical pressure. Neither water nor electricity can flow unless a pressure is provided. If we wish either the water or the electric current to flow faster (at an increased rate) the pressure applied to it must be increased.

Water pressure may be measured in pounds per square inch

but electrical pressure or electro-motive force is measured in volts. Sometimes electrical pressure is referred to as "voltage." E. M. F. is a convenient abbreviation to use for the long expression "electro-motive force" and it will be used hereafter in this text.

Resistance

When water flows through a pipe there is always a certain amount of friction between the water and the pipe. This hinders the flow of the water, that is, reduces the rate at which the water current flows. And the reduction in rate of flow depends directly upon the increase of the friction. Likewise there is friction present in the path of the electric current which acts as a "resistance" to the current flow. If the pressure or E. M. F. is kept constant the rate of current flow (current strength) increases as the resistance is decreased and vice versa. If, however, the resistance is kept constant it is natural to expect the current (rate of flow) of the electricity to increase with an increase of E. M. F. and vice versa. The current thus depends upon both the resistance and the E. M. F.

The unit of electrical resistance is called the "ohm" and if the resistance of a circuit is one ohm, one ampere of current will flow if the E. M. F. is one volt. This relation between current, E. M. F. and resistance is called "Ohm's Law" and is the first fundamental law of electrical circuits.

Direct Current

If the E. M. F. applied in a circuit is steady and only acts to force the current to flow in one direction through a circuit the resulting current is steady and is called a "direct current."

If the E. M. F. rises and falls but only acts in one direction the resulting current rises and falls and is called a "pulsating direct current" or a "pulsating current." Batteries produce a steady direct current in one direction through a circuit. Many dynamos, however, produce a pulsating E. M. F. which causes a pulsating current to flow (in one direction only) through a circuit. The periodical increases and decreases of E. M. F. and current may be made very small, however, so that they are hardly perceptible.

Alternating Current

Imagine that instead of a battery we have a dynamic generator of electrical pressure in a circuit and that the E. M. F. produced acts in first one direction, then the other, and that

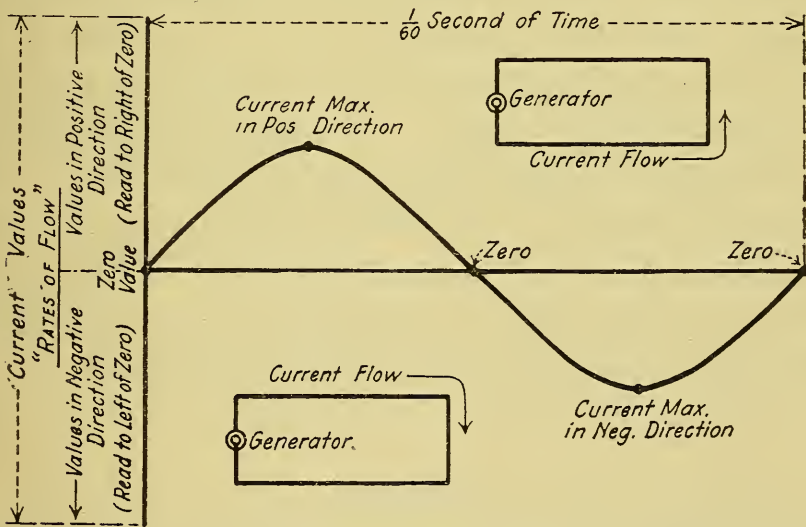

Fig. 3—One cycle of current changes and reversals. Frequency 60 cycles per second.

while acting in each direction it increases to a maximum value and decreases to zero. The current created will also change its direction of flow and increase and decrease in strength periodically, as shown in Fig. 3. Such a current could be

said to "alternate" in its direction of flow and is aptly called an "alternating current." These alternations or reversals of current flow, with their accompanying increases and decreases in rate of flow, take place very rapidly and at perfectly regular intervals. In this figure the current values or "rates of flow" are shown as increasing and decreasing in one direction above the horizontal line and increasing and decreasing in the opposite direction below that line. In order to distinguish the directions of flow from each other we may call one the "positive" direction and the other the "negative" direction, so that all current values along the vertical line and above the horizontal line are in the positive direction and all those along the vertical but below the horizontal are in the negative direction. During the period of time represented by the horizontal line the current has increased to a maximum value and decreased to zero in the positive direction then has reversed its direction and increased to a maximum and decreased to zero again. In increasing and decreasing, the current has passed through all values from zero to maximum in each direction. It has thus gone through one "cycle" of current changes and directions of flow. As long as the E. M. F. acts, the current will continue to go through these changes in a perfectly regular manner periodically.

Frequency

In the ordinary house lighting circuit, if it has alternating current, the periodical reversals of current flow usually take place at the rate of 60 cycles per second. It may be said then that the "frequency" of the alternating current is 60 cycles per second.

In radio work extremely high frequencies, varying approxi-

mately between 15,000 and 2,000,000 cycles per second, are also used. Such very high frequencies are called "radio frequencies." It is not within the scope of this little book to discuss the various methods of producing alternating currents of high frequency but it may be said that all radio transmitters do produce them and that they are very essential.

Inductance

Inductance, or, more properly, "self inductance," is a property possessed to a greater or lesser extent by every electrical circuit. It has no effect upon a direct current but does have an effect, which will be discussed, upon an alternating cur-

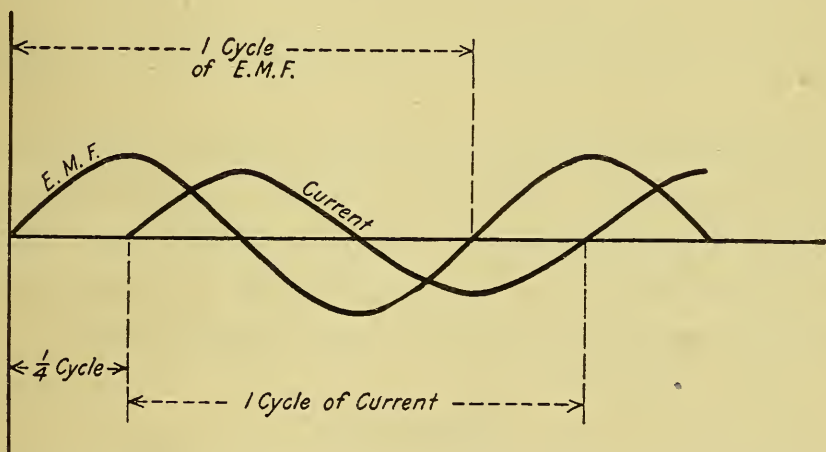

Fig. 4—Effect of inductance in an alternating current circuit.

rent. As shown in Fig. 4 it has the effect of causing the current to rise to its maximum value after the maximum value of E. M. F.

The current is said to "lag" behind the E. M. F.

"Reactance" is the name given to an "effective" resistance to alternating current which depends directly upon the value of the inductance and upon the frequency of the alternations.

In an alternating current circuit, if we for the moment disregard the actual resistance, the average value of current decreases as the reactance increases providing that the E. M. F. has a constant average value. That is, the reactance has the *effect* of a resistance although it is not true "ohmic" or actual resistance. If the circuit contains reactance *and* ohmic resistance, the average current value will decrease with an increase in either or both providing again that the average E. M. F. is constant.

A straight wire possesses inductance to some extent and the inductance of a wire increases with its length. Given a certain length of wire, its inductance and therefore its reactance may be very greatly increased by coiling it. Also, if more turns are added to the coil or if an iron core is placed inside of it, its inductance is increased and its reactance as well.

To distinguish this type of reactance from a type considered below we may call it "inductive reactance." To sum up, then, inductive reactance depends directly upon the inductance and frequency of current. The average value of alternating current in a circuit varies inversely with the reactance.

Capacitance

Capacitance, or, as it is sometimes called, "capacity," has exactly the opposite effect of inductance upon an alternating current. Capacitance has the effect of causing the current to rise to its maximum value before the E. M. F. The current in this case is said to "lead" the E. M. F., as is graphically shown in Fig. 5.

* The reciprocal of the product of capacitance and fre-

* If the product were 2, the reciprocal would be $\frac{1}{2}$. The reciprocal of 3 is $\frac{1}{3}$, of 2×100 it is $\frac{1}{2 \times 100}$ and so forth.

quency determines the value of a reactance which in this case may be called a "capacitive reactance." The capacitive reactance, however, does not have the effect of a resistance to the alternating current but exactly the opposite. The average

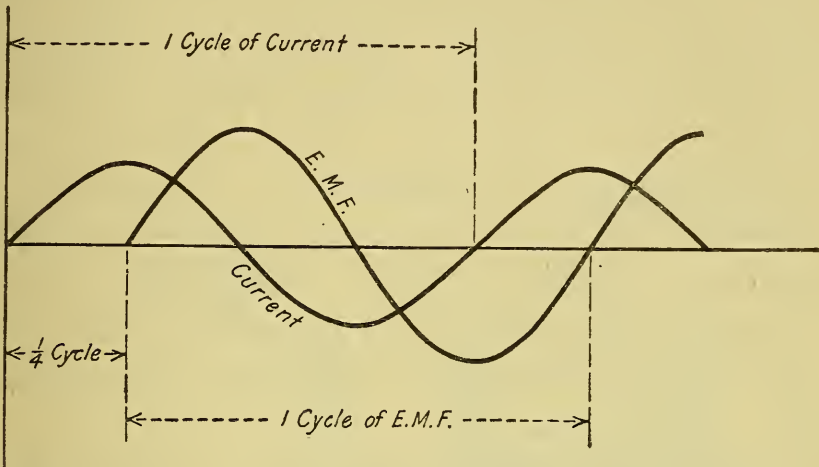

Fig. 5—Effect of capacitance in an alternating current circuit.

current value depends directly upon the capacitive reactance in a circuit, providing the average value of E. M. F. is kept constant. The average value of the alternating current then increases with an increase in either the average E. M. F. or the capacitive reactance and decreases with an increase of actual resistance. Capacitive reactance decreases with an increase of either capacitance or frequency, and vice versa.

A straight wire has some capacitance which increases with the length of the wire. Coiling the wire will also increase its capacitance. But since inductance is the predominant property the capacitance of a wire or coil is very small in comparison.

If two metallic plates are assembled with a sheet of glass between them there is produced what is known as a "condenser." This arrangement would have a very appreciable capacitance. To increase the capacitance of this con-

denser we could (1) increase the area of the glass and the metallic plates; (2) decrease the thickness of the glass (the distance separating the metallic plates); (3) use a substance between the plates which has a higher "dielectric constant." The material between the plates, whatever it may be, is called the "dielectric" and although it may not be an absolute insulator it does have a very high resistance, usually, to the passage of a current. Air is assumed to have a "dielectric constant" of unity (or one) and if a condenser with the same dimensions has a dielectric which gives five times the capacity of the air condenser, the "dielectric constant" of the other material is five. Some dielectric constants in the order of their increase are: Air—1, paraffine—2; hard rubber—2.5; glass—6 to 8; mica—8.

It would be very convenient at times to have a variable capacitance whose value could be adjusted at will. If the maxi-

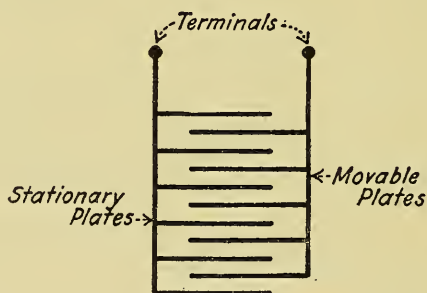

Fig. 6—Scheme of a variable condenser. (If the movable plates are made stationary it is a "fixed" condenser.)

imum value is not necessarily very large, an air dielectric may be used. A number of movable plates could be arranged so that they interleave with a number of stationary plates without touching them. All the stationary plates are connected together and to a terminal and the movable plates are connected together and to a second terminal. There will be an increase in the

maximum capacitance obtainable if more plates are used because this will increase the total plate area, the dielectric being the air between the stationary and movable plates. Fig. 6 shows how the plates are interleaved and Fig. 7 illustrates a variable condenser with and without its case.

The question may be asked, "How does an electric current flow through a condenser if the dielectric is a good insulator

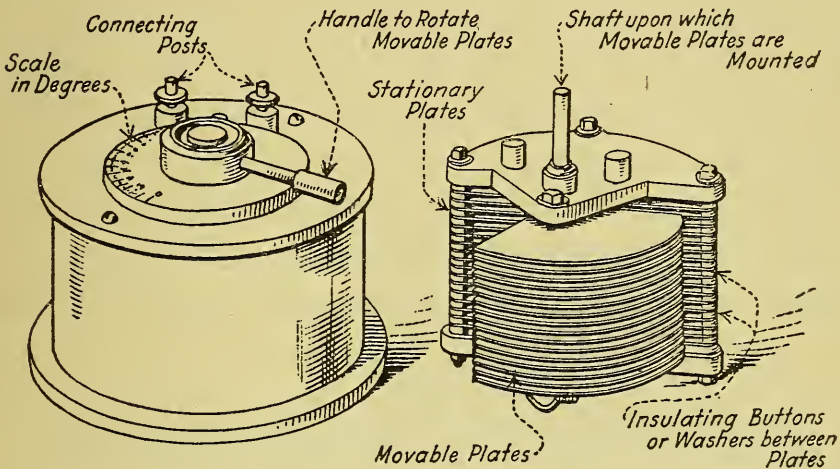

Fig. 7—Typical variable condenser with air dielectric.

and prevents the passage of current?" A direct current will not flow through a condenser and neither will an alternating current. But the alternating current will appear to flow through because in all parts of the circuit on either side of the dielectric it rises and falls in rate of flow back and forth between the dielectric and the source of E. M. F. To make the matter more clear, suppose an analogy is considered. In Fig. 8 a pipe full of water is represented with an elastic partition at "A" and a pump at "B." The pump is so arranged that the to-and-fro motion of the piston exerts a pressure periodically in one direction then the other and causes the

water, therefore, to flow in each direction periodically. The water does not flow past the elastic partition at any time. But, the elasticity of the partition allows it to stretch and during the time the current is forced in the direction of the full line arrow, it stretches and exerts a back pressure upon the water exactly equal to the pressure of the pump at every instant. When the pump pushes the water in the opposite direction the partition stretches in the opposite direction and again exerts a back pressure equal at every instant to the pump pressure. There is thus a surge of water back and forth through the pipe, causing the partition to stretch in first one direction then the other, within the limit of its elasticity. And, then, as far as the pipe is concerned, there is an alternating current of water in it in spite of the partition. The dielectric of a condenser is the "partition" and it must have electrical elas-

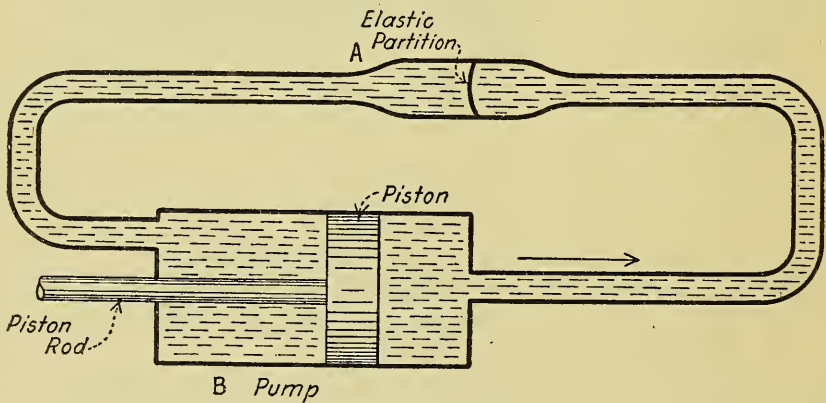

Fig. 8—Water analogy of alternating current in a circuit containing a condenser.

ticity, otherwise it might be ruptured in the same manner that the partition in the pipe would be, if the pump pressure became too great. It is thus readily seen that while an alternating current does not actually flow through the dielectric, the current does alternate in the circuit in spite of the dielectric.

Resonance

Suppose two tuning forks are tuned to the same musical pitch and placed a foot or so apart. If one is struck a light blow it vibrates and a sound is heard which is the musical pitch dependant upon the rate of vibration of the fork. The fork is setting up waves in the air which reach the ear and are translated by the brain into a musical tone which is recognized. What is perhaps more interesting, however, is that the second tuning fork also vibrates in sympathy with the first. If the first fork is grasped in the hand to stop its vibration, the second will still vibrate for a short time and emit a musical tone exactly of the same pitch as the first one. It is evident that the second fork is vibrating at the same rate as the first before it was grasped. It is said to be "in tune" or "in resonance" with the first.

Suppose, however, that the first tuning fork is adjusted so that, when struck, it vibrates at a different rate. This time the second one will not vibrate in sympathy as it would if it also had been adjusted to vibrate at the same rate. The two forks are then not in tune with each other and the second is "out of resonance" with the first.

In the first case the second fork was forced to vibrate at the same mechanical frequency (of vibration) as the first fork, because it was in resonance. In the second case there was no resonance, so the second fork was unaffected.

An electrical circuit in which an alternating current flows does not vibrate mechanically, but it may be thought of as vibrating electrically. Also, one electrical circuit may be adjusted so that it is "in resonance" with another and so that an alternating current flowing in one will produce an alternating current in the other of the same frequency. In this

case of "electrical resonance," the second circuit is caused to "vibrate electrically" in sympathy with the first.

Oscillations

Alternating electrical currents of extremely high frequency are said to be alternating at "radio frequencies," as has been noted. And such high frequency alternating currents are

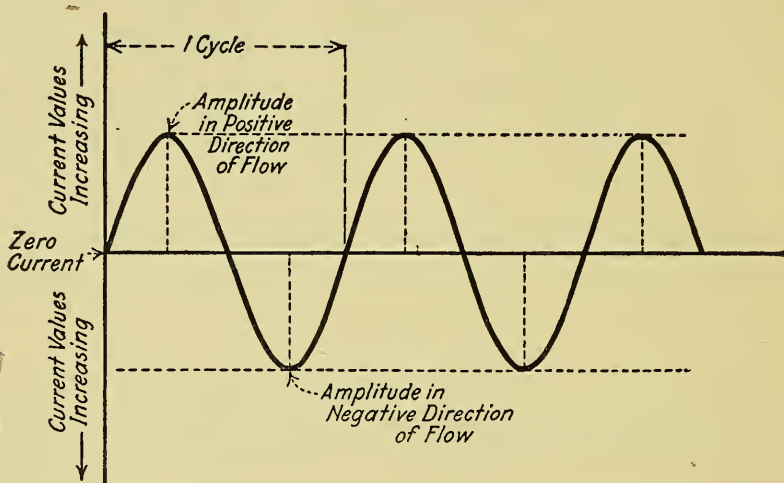

Fig. 9—Continuous oscillations.

called "Radio frequency alternating currents." Instead of using this long name a shorter one has been selected for practical use, and it is said that such alternating currents are "oscillations." A definition of oscillations may then be, "radio frequency alternating current."

The maximum value of current strength attained in each direction of current flow during each cycle is called the "amplitude." If successive amplitudes are of equal values as long as the current flows, the oscillations are said to be "continuous oscillations." An alternating E. M. F. of constant amplitude is, of course, necessary to the production of continuous oscil-

lations. Fig. 9 may assist the reader to understand this term. An ordinary, low frequency, alternating current also has constant amplitudes.

If an E. M. F. has constantly decreasing amplitude it will produce a current of constantly decreasing amplitude. Also, if the amplitudes of the E. M. F. decrease rather rapidly, the current will cease to flow after a short period of time because of the absence of E. M. F. to force it to flow. If, then, the successive amplitudes of oscillations decrease, the

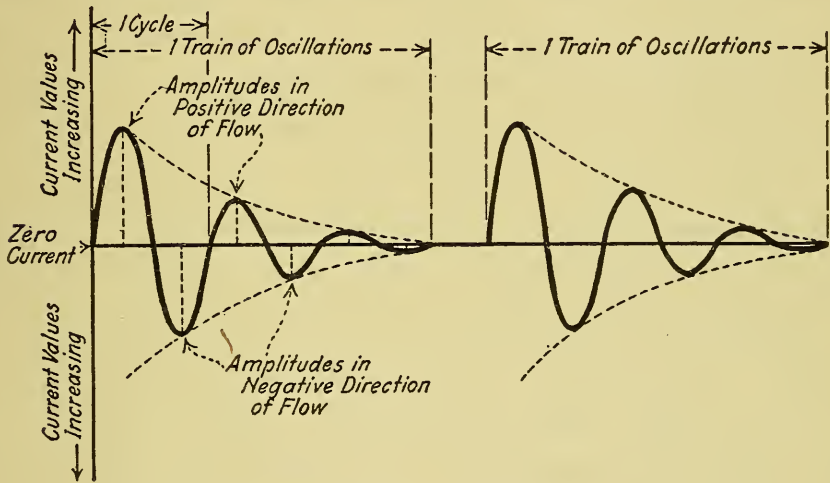

Fig. 10—Damped oscillations.

oscillations may be said to be “damped,” and there is produced what are called “damped oscillations.” Sometimes continuous oscillations are referred to as “undamped oscillations,” because their successive amplitudes are not damped. When damped oscillations finally cease they are said to be “damped out.” Fig. 10 will assist in understanding this matter. Two series, or groups, of damped oscillations are shown, and each series may be referred to as a “train” of damped oscillations.

If an electrical shock were given to a circuit containing inductance and capacitance, that is, if an electrical pressure

were suddenly applied and immediately withdrawn, the circuit would vibrate electrically in the same manner as the struck tuning fork vibrated mechanically. An alternating current would be produced in the circuit, providing its resistance were not too great, but the successive amplitudes would decrease and the oscillations would die out just as the vibrations of the tuning fork die out a short while after the fork is struck. In the second circuit, just as with the second fork, even though there is resonance the vibrations die out after a short time.

If, however, the first tuning fork were tapped very lightly at the end of each swing it would continue to vibrate as long as the tapping took place at the proper times and in the proper amounts to maintain these vibrations (or swings). The regular periodical tapping may be compared to a regular periodical E. M. F. applied in an electrical circuit. If the E. M. F. is applied at the proper times and always in the same amounts, the oscillations will not decrease in amplitude but will be "continuous." Now, in the case of the tuning forks, if the vibrations of the first one are continuous (due to continuously applied taps), the vibrations of the second one will continue and be of constant amplitude. Likewise, in a second electrical circuit, if the oscillations in the first are continuous those in the second will also be continuous. Continuous oscillations in a second circuit are then the result of a continuously applied E. M. F. in that circuit due, in turn, to a continuously applied E. M. F. (and therefore oscillations of continuous amplitude) in the first circuit.

The action of producing oscillations in a second circuit by creating oscillations in a primary circuit is called "induction," and we may say that when oscillations are produced in a secondary circuit they are "induced" therein.

The Reception of Signals

It should now be quite clear that if oscillations are produced in a suitable circuit at a transmitting station oscillations will be produced by induction in a suitable circuit at a receiving station, when the two circuits are in resonance with each other. Each of the circuits is called an "antenna," or sometimes, an "aerial," since each is frequently erected so that it extends some distance from the earth up into the air.

When vibrations are induced in a tuning fork by another, the air between them is set in motion and it is this air which transmits the motion from one fork to the other. That is, the first fork sets the air into vibration and the vibrating air sets the second fork into vibration. Another illustration would be the dropping of a stone into a quiet pond of water. Water waves radiate from the point where the stone strikes the water until they reach a cork located a distance away. The cork is set into motion and bobs up and down, or oscillates. But the cork does not move further away from or closer to the point where the oscillations were created in the water. This proves that the water itself does not travel from one place to another but that the oscillating motion is transmitted or radiated from the point where the disturbance occurs. In the case of either the air or the water it is the oscillatory or vibratory motion which is transmitted.

This throws some light upon electrical induction. But in the case of oscillations produced in a secondary electrical circuit neither air nor water is necessary to transmit the motion. In fact, electrical oscillations in a circuit have no effect upon either air or water. There must be some medium, however, which is capable of being set into vibration by the electrical oscillations and will, in turn, create electrical oscillations

in a distant circuit. This medium is called the "ether," and is one which pervades all space. It is present in the entire universe where water and air may be entirely absent. It is, in fact, the ether which is set into vibration by the oscillations in a transmitting antenna. These vibrations spread out in circles just like the ripples in the water after a stone is dropped and when they reach a receiving antenna, create electrical oscillations in that circuit. The whole purpose of "radio" is to create ether vibrations and to translate them at a distant point.

Now, assume that continuous oscillations or recurrent trains of damped oscillations are produced in a transmitting antenna and either continuous or recurrent trains of damped oscillations are induced in the receiving antenna. We still lack a device to make the received oscillations perceptible to one of our senses. But in a following chapter means for accomplishing this necessary result are considered.

Wave Length

The ether vibrations or oscillations have the same frequency as the electrical oscillations which create them. Moreover, this oscillatory motion of the ether is projected through it with the speed of light, light being only ether vibration at considerably different frequencies. This rate of speed is 300,000,000 meters (approximately 186,000 miles) per second of time. Almost too rapid a rate to conceive—in fact, ether oscillations caused by electrical oscillations travel over seven times around the earth in one second.

The ripples created in a pond of water by the dropping of a stone travel about 10 to 100 centimeters per second, a centimeter being roughly equivalent to one-hundredth of a yard.

The ripples are, of course, small water waves, and if we know their rate of travel and their frequency of production, we can easily calculate the length of one wave. For example, one wave is produced each second and travels a distance of one yard in that length of time. What is the length of the wave? It is, of course, the rate of travel (one yard in one second) divided by the frequency of wave production (one cycle per second or one wave per second), and equals, in this case, one yard. Likewise, if an ether wave travels 300,000,000 meters per second and the frequency of its oscillation is 300,000, its length must be 1,000 meters. That is, the wave length (length of one wave) is the result of dividing the velocity (distance traveled per second) by the frequency (number of waves per second). There are, of course, the same number of waves per second as cycles of oscillation. In speaking of these ether vibrations it is customary to think of their wave length rather than their frequency. If a transmitting station is said to "radiate" a "wave length" of 200 meters, what is meant is that the ether in the neighborhood of the transmitting antenna is set into vibration at the rate of 1,500,000 times per second (frequency equals 1,500,000) and that the length of each ether wave created is 200 meters.

Tuning the Receiving Antenna

Under "Inductance" and "Capacitance" it was brought out that inductive reactance has the effect of a resistance upon an alternating current and that capacititive reactance has just the the opposite effect. It was also brought out that inductive reactance increases and capacitive reactance diminishes with increased frequency and vice versa. If, then, a circuit has an inductance and a capacitance selected at random there will be a certain frequency at which the two reactances are equal and,

since they are exactly opposite, the total reactance is zero. This frequency is called the "resonance frequency." On the other hand, if a certain frequency is selected at random then the two reactances must be adjusted so that they are equal for this frequency and, since they are opposite, they will then neutralize each other and the total reactance will be zero.

Now, when a receiving antenna is acted upon by ether vibrations of a certain definite frequency (the frequency of the oscillations in the transmitting antenna) an alternating (oscillating) E.M.F. is produced and an oscillating current will *tend* to flow in the antenna. Whether or not the current will actually flow and whether it will be of maximum value for the E.M.F. applied, will depend upon both the actual resistance and the total reactance (effective resistance) in the antenna circuit. The actual resistance may be assumed to be and in practice is, fairly low, and with an antenna already erected it is, on the whole, a fixed value. The current then depends upon the total reactance which, as has been stated, may be made zero by the proper adjustment of inductive and capacitive reactance. If the reactances are made equal for this definite applied frequency then the antenna may be said to be "tuned" or "in resonance" with the frequency and therefore with the frequency of oscillations in the transmitting antenna. Since inductive reactance may be increased and decreased by varying the number of turns of wire on a coil and since capacitive reactance may be increased and decreased by allowing the movable plates of a variable air condenser to interleave to a greater or lesser extent, tuning may be accomplished by either a variable coil or a variable condenser.

Increasing the inductance of the coil or the capacitance of the condenser means that the resonant frequency is decreased, providing the coil and condenser are in series with each other in the

circuit. That is, if the circuit is in resonance with a certain frequency and either the inductance of the coil or the capacitance of the condenser is increased, the circuit is no longer in resonance with this frequency but would be in resonance with a lower frequency of ether oscillations produced by, perhaps, some other transmitting antenna. The counter condition is of course true, that if the coil inductance or the condenser capacitance were decreased, the circuit would then be in resonance with a higher frequency of ether oscillations produced, possibly, by still another transmitting station. Either one of these stations or any one of possibly a large number of stations might then, of course, be picked up at will by simply tuning the receiving antenna circuit in this manner.

Wave-length of ether oscillations is perhaps thought of more popularly than frequency, and under "Wave Length" it was pointed out that as the frequency of oscillations increases their wave length diminishes and vice versa. If, then, we wish to speak in terms of wave-length, we may say that an increase of inductance or capacitance in a receiving circuit increases the wave length at which that circuit is in resonance and that a decrease of either of them decreases this wave length. Speaking still in terms of wave length rather than frequency, it may now be said that tuning is simply the process of adjusting inductive reactances (coils) and capacitive reactances (condensers) in a circuit so that, for the wave length of the ether oscillations acting upon the (antenna) circuit, the two reactances are equal and, being opposite, neutralize each other to reduce the total reactance to zero.

The Antenna as a Complete Circuit

As a general rule, the antenna appears not to be a complete circuit. If Fig. 11 is considered it is seen that there is a capaci-

tance effect (or a condenser effect) between the free end of the antenna and the end connected to earth or to a "counterpoise" consisting of a number of wires stretched beneath the antenna. That is, every inch of the antenna has a capacitance to earth (or to the counterpoise) so that considering the antenna as a

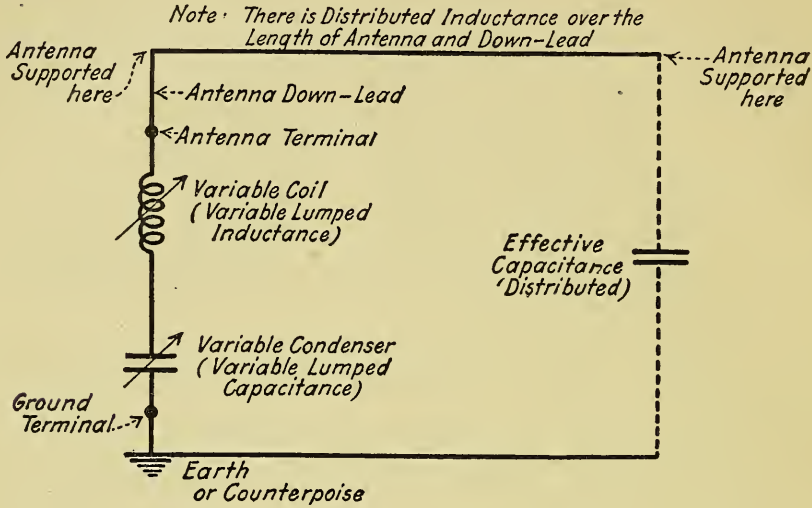

Fig. II—Scheme of antenna as a complete circuit.

whole, it may be regarded as one plate of a condenser, with the earth or counterpoise acting as the other plate. There is then a circuit which is closed so far as alternating current (especially radio-frequency alternating current) is concerned and current readily flows in the circuit under the proper conditions mentioned above.

The reason that an antenna, particularly a transmitting antenna, has to be elevated a considerable distance above the earth is in order to allow a large amount of ether to be acted upon and set in motion by the antenna oscillations. It is readily seen that the higher the antenna the larger the amount of ether there is between its top and the surface of the earth. In the case of a receiving antenna this also applies to a considerable extent, since in this case it is desirable to have as large an amount of

vibrating ether acting upon the circuit as possible. The response in a device to make signals perceptible to our senses depends very greatly upon the auxiliary devices used, and it is possible to provide such sensitive apparatus and to amplify currents so greatly that a low receiving antenna may be entirely permissible. The devices to be considered in the following chapters are indeed so sensitive and can be made to amplify currents to such great extents that receiving antennae may even be done away with in practise. It must be borne in mind, however, that no matter how efficient the receiving apparatus may be, better results are obtained with the use of antennae which are the better, the higher they are erected.

In the following chapters the little lamps called "vacuum tubes" "audions," "radiotrons," and so forth, are considered. Results obtained with them are truly remarkable and it is due to their adoption that such long ranges are now possible in radio communication without any increase in the power of transmitting stations. Their action is truly absorbingly interesting.

CHAPTER II.

THE VACUUM TUBE AS A RECTIFIER AND RELAY WITHOUT MOVING PARTS

Tube construction—The Edison Effect—Electron emission from a heated filament—Dependence of plate current upon plate potential—Dependence of plate current upon filament current—Effect of grid potential upon plate current—Relay action—Rectification.

Tube Construction

A vacuum tube is somewhat similar in construction to an ordinary incandescent electric lamp which has a filament supported inside a glass tube or bulb from which the air has been exhausted. When an electric current flows through the lamp filament it is heated to incandescence and produces light. A vacuum tube also has a filament which may be made incandescent by allowing electric current to flow through it, but the production of light in this case is merely an accompaniment of more essential phenomena as will be explained.

When air is exhausted from any kind of a vessel a vacuum remains and the degree of vacuum depends upon the degree of air exhaustion. The vacuum within a so-called "vacuum tube" is very much higher than that within an incandescent electric lamp. What are known as "hard" tubes have an extremely high vacuum, often indeed the highest possible vacuum attainable. Others known as "soft" tubes contain a small amount of gas and, therefore, a somewhat lower vacuum. Each class of tube has its particular uses, although the "hard" tubes may be used for all purposes.

Regardless of the degree of vacuum, a tube contains, in

in addition to a filament, a "grid" and a "plate" arranged, for example, as in Fig. 12. The grid is always placed between the filament and the plate.

The filament is usually of very fine tungsten wire and may be straight, "V" shaped or shaped like a "W." The apexes

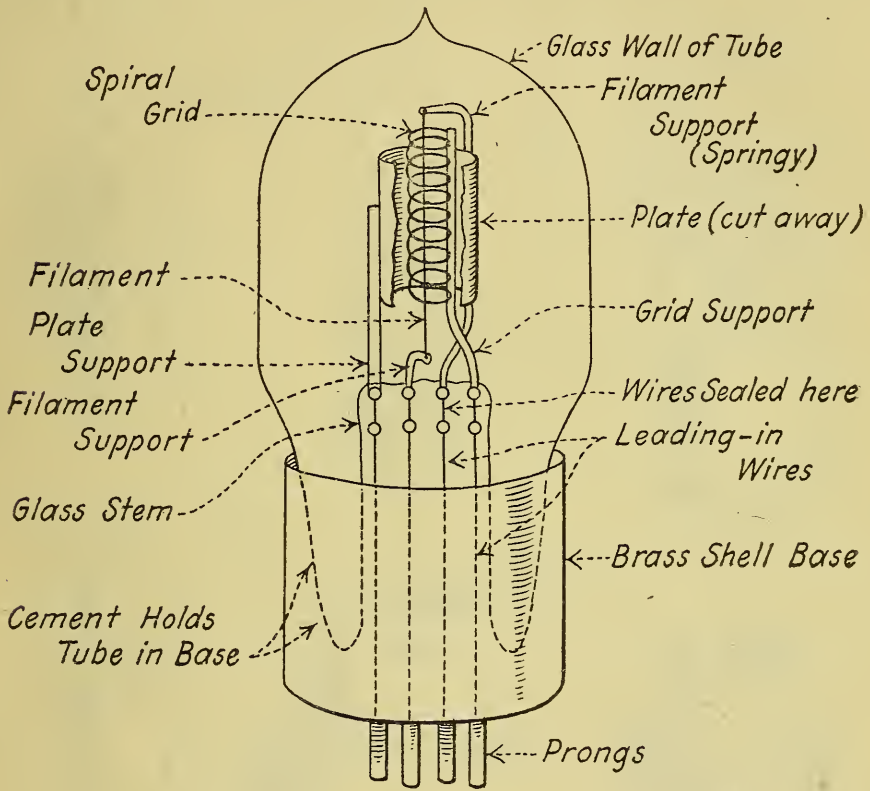

Fig. 12—Construction of a typical vacuum tube.

of the "V" and "W" shaped filaments are upwards. No matter what the filament shape, it is supported in such a manner as to prevent its displacement when jarred. The tube of Fig. 12 has a straight tungsten filament supported at its upper end by a nickle rod, to which it is carefully welded. The lower end of the filament wire is welded to a shorter nickle rod and both rods are anchored into a glass stem. The longer rod is springy, so that it will hold the filament taught.

The grid may be a mesh of nickle wire wound about two supports. In the figure it is shown as a spiral or helix, so supported by a nickle rod that the filament becomes the axis of the spiral. Each turn of the spiral grid is welded to a nickle supporting rod, the lower end of which is anchored into

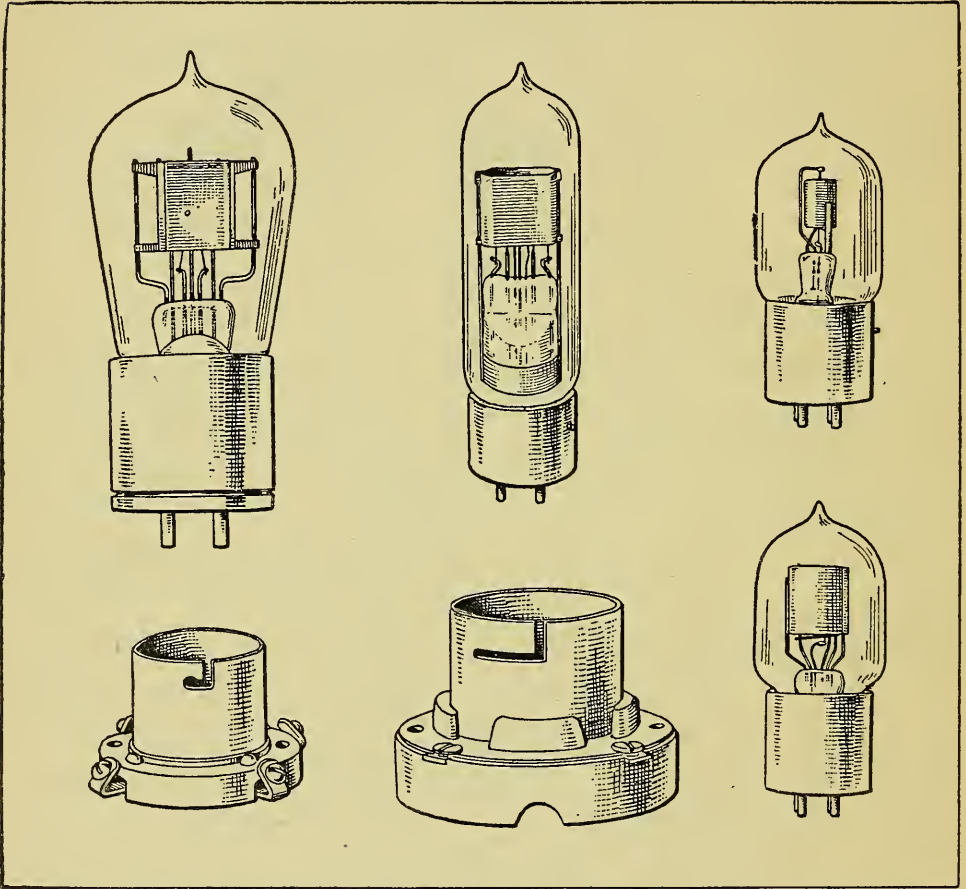
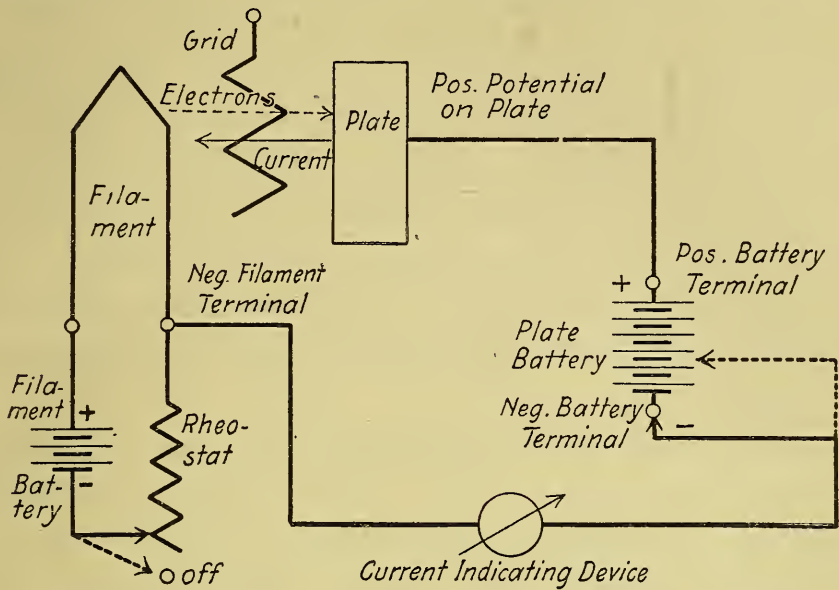

Fig. 13—Various forms of vacuum tubes and sockets.

the glass stem. The grid must, in any case, be rigid enough to withstand considerable jarring.

The plate may be of molybdenum, nickle or thin sheet steel. It is quite often cylindrical in shape, but may also be flat or shaped like a cylinder flattened out on two sides. The plate



(A)

Plate Current Flows.

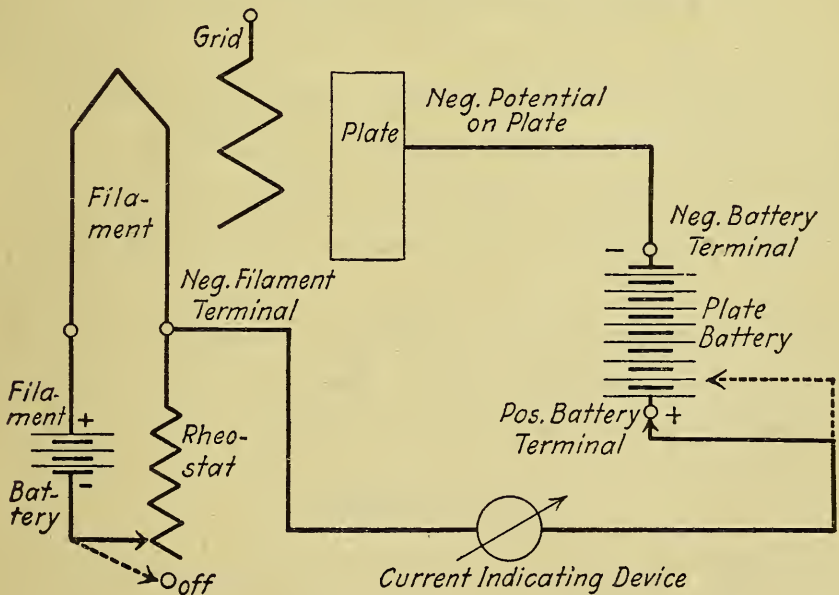

(B)

No Plate Current Flows.

Fig. 14—The Edison Effect or one way conduction of electric current within a vacuum tube.

must also be rigidly supported. In the figure there is a cylindrical plate of nickle so supported by a nickle rod that it encloses the grid and, therefore, the filament. The filament is then the axis of both the spiral grid and the cylindrical plate. The plate support is welded to the plate and the lower end of the support is securely anchored into the glass stem.

There are, then, three members called "electrodes," the filament, the grid and the plate. A vacuum tube is seen to be a somewhat more complicated device than the incandescent electric lamp.

The four prongs which extend below the base of the tube are for connection into a circuit. Each of these is welded to a leading-in wire which connects it to a support. In this manner the two filament ends, the grid and the plate are each connected to a prong. The leading-in wires are very carefully welded to the supports and sealed into the glass stem, so that at no future time may there be any leakage of air into the tube. Air leakage would render the tube unfit for use.

Fig. 13 illustrates a few of the various forms of tubes and some tube sockets or receptacles. When a tube is inserted into a socket, each tube prong makes contact with a spring contact piece which is connected to a terminal binding post. Two binding posts are for the filament connections and one each is for the grid and the plate. This provides a convenient way of holding a tube and connecting it into a circuit.

The Edison Effect

In both Fig. 14-A and 14-B there is a battery called the "plate" or "B" battery connected between the plate and one of the filament leads. In each figure, also, a very sensitive current indicating device is connected into the plate circuit. Current may be allowed to flow through the filament from a

smaller battery called the "filament" or "A" battery. The current flowing through the filament may be controlled by a variable resistance in the filament circuit. This variable resistance is called a "rheostat." Increasing this resistance causes decreased filament current and vice versa. Also, of course, if the filament rheostat is turned off, no current flows in the filament. When there is no current flowing in the filament it is cold, but when current is allowed to flow, the filament is thereby heated to a temperature depending upon the current strength. The filament rheostat may, therefore, be used to control the filament temperature by controlling the filament current.

Suppose that the filament current is turned off (filament cold) and the positive terminal of the plate battery is connected to the plate, as in Fig. 14-A. Observation of the current indicating device shows that no current flows in the plate circuit.

With the filament still cold (rheostat turned off) the plate battery connections are reversed so that the negative terminal of the battery is connected to the plate, Fig. 14-B. Observation again shows that there is no current flowing through the indicating device.

The negative terminal of the plate battery is still connected to the plate and the rheostat is now turned on, allowing enough current to flow through the filament to heat it to incandescence. Observation once again shows no current in the plate circuit through the indicating device.

Now, with the filament still glowing, the plate battery connections are changed back again so that the positive battery terminal is connected to the plate, as in Fig. 14-A. This time there is an appreciable current indicated as flowing in the plate circuit from the positive terminal of the battery to

the plate, across the space within the tube to the filament and back to the battery. This is an interesting state of affairs. A direct current of electricity is flowing from the plate to the filament through the vacuum of the tube. There is electrical conduction between these two points, but only when the filament is glowing and the plate is connected to the positive terminal of the plate battery.

This phenomenon of one way conduction of electric current through a vacuum was noted by Thomas A. Edison and is termed "the Edison effect." Like numerous other discoveries, however, it was not fully investigated and used until some time later.

Electric current always flows or tends to flow from a point of high to a point of low potential. This may be compared to the flow of water down a hill. A point in the stream at the top of the hill is at a higher "potential" than a point in the same stream at the bottom of the hill. In the case of electricity, the high potential point is said to be the point of "positive" potential and the lower potential point that of "negative" potential. An electric current, therefore, flows or tends to flow always from a point of positive to a point of negative potential. When the positive terminal of the plate battery is connected to the plate, the potential of the plate is positive with respect to that of the filament, because current will flow from the plate to the filament, inside the tube, providing the filament is lighted. The glowing filament, in this case, causes the path or circuit from plate to filament to be closed.

Electron Emission from a Heated Filament

The smallest possible particle of negative electricity is called an "electron." The word means "carrier of electricity." An

electron is then the smallest possible negative electric charge and is, moreover, a carrier of electricity. When the filament is heated, by the electric current flowing through it, thousands of these electrons are projected at high velocity from it like buckshot from a shotgun. The higher the filament temperature the more electrons there will be projected in any given length of time. Now, when the filament projects an electron from itself, it loses a minute portion of its negative charge and, since the negative and positive charges are normally equal, if the filament loses some of its negative charge, the charge remaining upon it is positive. If there is nothing to prevent it, then, the filament will attract electrons back to itself at the same rate as they are emitted. Considering the space within the tube, there are electrons in constant motion, some away from and some back to the filament. It must be remembered that unlike charges of electricity attract each other and that like charges repel each other.

If the plate, however, is now given a positive charge by connecting it to the positive terminal of a battery, as in Fig. 14-A, it will attract to itself at least a portion of the electrons present in the tube space. These electrons, being current carriers, then cause a current of electricity to flow from the plate to the filament and back through the battery, the battery being the source of the current. That is, when electrons are attracted to the plate the space between it and the filament is made conducting and a current flows from the battery. The strength (or rate of flow) of this plate current depends upon the number of electrons (current carriers) which bridge the filament-plate space per unit of time. In other words, the current depends upon the *rate* at which electrons are attracted to the plate.

If the plate is negatively charged (its potential negative

with respect to the filament) no plate current can flow because the plate repels the electrons. (Like charges repel). That is, if there are no electrons bridging the space between filament and plate no conduction can take place.

This, then, explains why there is electrical conduction through a vacuum when the filament is glowing and the plate is positively charged and, also, why there is no conduction when the plate is negatively charged or the filament is cold.

Dependence of Plate Current upon Plate Potential

The positive potential of the plate determines the number of electrons which may be attracted to it per unit of time and, therefore, the strength of the plate current. But suppose that the plate potential has been increased up to the point where electrons are attracted just as rapidly as they are shot from the filament into the tube space. A higher plate potential will not be able to attract them in any greater numbers, per unit of time, because it is already attracting them just as fast as they are being emitted from the filament. There is a limit, then, to the increase of plate current with an increase of plate potential. If larger plate current is desired, electrons must be projected from the filament in greater numbers.

The value of the positive potential on the plate depends upon the voltage of the plate battery. Therefore, in view of the foregoing, the plate current increases with the battery voltage only up to a certain point, providing no change is made in the filament current. If the filament current is increased by a certain amount, the plate current increases, with increase in battery voltage, up to a new point, after which no further current increase may be had unless the

filament current is again increased. There is, of course, a limit to the current which may be made to flow through the filament if it is not to be burned out. There is then a final limit to the current which can flow in the plate circuit no matter how high the plate battery voltage may be made. In practice, it is desirable to burn the filament at a moderate temperature and to secure the desired plate current by selecting the proper plate battery voltage. This will lengthen the life of the tube filament.

Dependence of Plate Current upon Filament Current

The rate of electron emission increases, as has been said, with the increase of filament current (increase of filament temperature). If the plate potential is held at a constant value and the filament current is increased, there will be an increase of plate current up to a certain point. The point where no further increase of plate current is had with increasing filament current is that at which the filament is emitting electrons as fast as the plate can attract them. Then, no matter how much faster the electrons are shot from the filament into the tube space, the plate will only attract a certain number of them per unit of time.

If the electrons are emitted at still increasing rates there will be no increase of plate current unless the potential of the plate is raised (plate battery voltage increased) in order that the plate may attract them in greater numbers per unit of time.

If there are more electrons emitted by the filament per unit of time than the plate can attract, some of the electrons in the tube space are continually reaching the plate while others are falling back upon the filament.

Another way of viewing this matter is to consider the

lumped effect of all the electrons in the tube space between filament and plate. Since each electron is a negative charge, the total electric charge in the space is negative. There are, then, two electric charges acting upon the electrons just leaving the filament. One is the positive charge of the plate and the other is the negative charge of the space (negative space charge). If the positive charge of the plate is greater than the negative charge of the space, electrons will be drawn to the plate from the space and others will be pulled into the space (from the filament) to take their places. But if the positive plate charge is exactly neutralized by the negative space charge, this space charge will repel one electron back to the filament for every extra electron projected from the filament into the space. Only a certain number of electrons per unit of time are, therefore, attracted to the plate and the plate current is at maximum value. This is called the "space charge effect."

Suppose that some concrete hypothetical examples are considered. The plate potential is assumed to be at such a positive value (due to plate battery voltage) that it can attract 1000 electrons per second. The filament temperature is low, at the start, and only 100 electrons are emitted from it per second. The 100 electrons are shot into the tube space each second to make the negative space charge at all times equal to that of 100 electrons. The plate charge is greater, however, and pulls electrons out of the tube space at the rate of 100 per second. This corresponds to a certain value of plate current. Now, the filament temperature is increased and 500 electrons are emitted per second. The plate will attract 500 electrons per second and the plate current is increased. The effect of the plate charge is still greater than that of the space charge. The filament temperature is again increased and

to such an extent, this time, that 1000 electrons are emitted per second. The plate now attracts 1000 electrons per second from the space. The effect of the plate charge is now equal to that of the space charge, so that for every electron shot into the space, one is attracted to the plate. But now suppose that the filament temperature is again increased until 1500 electrons are emitted per second. There are now 1500 electrons present in the space each second. The plate can only attract 1000 of them from the space so the negative space charge repels the extra 500 back to the filament. The plate current does not increase, because no matter how many electrons over 1000 per second are emitted, only that number per second are actually drawn to the plate from the space. If the potential of the plate is raised until it is able to attract 1500 electrons per second, the plate current increases until the plate is actually attracting 1500 electrons to it each second. Then the space charge again equals the plate charge and if electrons are emitted at a still greater rate, say 2000 per second, there are still only 1500 reaching the plate per second and the plate current remains constant at the higher value.

Effect of Grid Potential upon Plate Current

It has been pointed out that the grid electrode is located between the filament and the plate of a tube. The grid must then, of course, be situated in the region of the space charge.

If a positive potential is applied to the grid by a grid battery, as in Fig. 15, its potential is positive with respect to the filament and the positive charge thus placed upon the grid neutralizes some of the effect of the space charge. The result is an increase in plate current and the grid may be said to be adding the effect of its positive charge to that of the plate in order to cause more electrons per second to be attracted to the latter. If the positive

charge on the grid is sufficiently increased, however, the plate current ceases to increase because electrons are then being attracted to the plate just as rapidly as possible. A saturation point is then reached. When the grid is positively charged it will also attract some electrons to itself and cause a current to

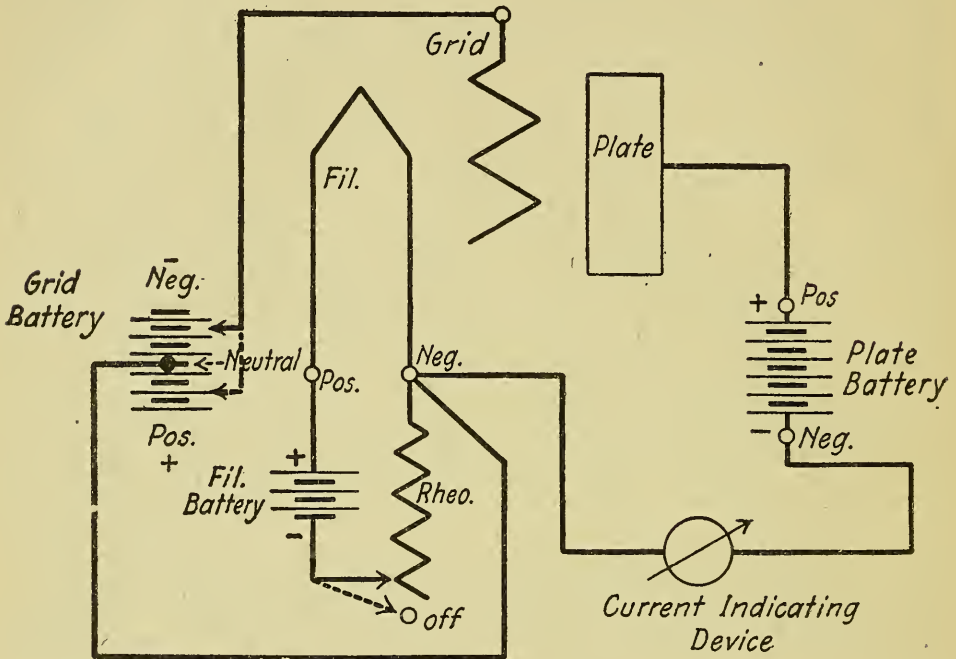

Fig. 15—One method of varying the grid potential.

flow in the grid circuit, from grid to filament inside the tube. This grid current also increases, up to a certain point, with the increase in positive grid potential.

If a negative potential is applied to the grid from the grid battery, its effect will be added to that of the space charge. The result is a decrease of plate current and the grid may be said to be opposing the effect of the plate. When the grid is negatively charged, it repels electrons back to the filament and therefore no grid current flows. Electrons in large numbers may, however, pass through the spaces between the grid wires because of

their high velocity and be attracted by the plate. If the grid potential is too negative it will completely neutralize the effect of the positive plate charge and cause the plate current to be

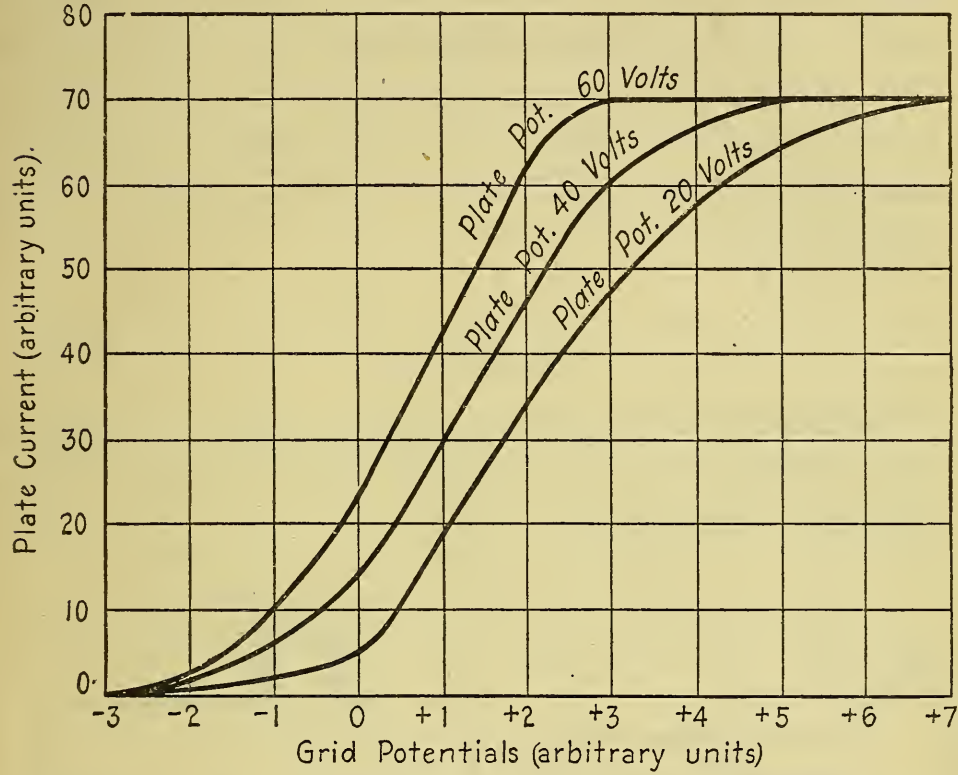

Fig. 16—Characteristic curves of grid potentials and corresponding plate current values.

reduced to zero. This value of negative grid potential is called the “cut-off” potential.

The external portion (part outside of the tube) of the grid circuit is connected at one end to the grid and at the other to the filament. Therefore when potentials are applied to the grid, they are either positive or negative with respect to the filament. That is to say, when a higher potential is applied to the grid than to the filament its potential is “positive” with respect to the filament. The reverse is also, of course, true.

A graph is shown in Fig. 16, which pictures the effect of

various grid potentials upon plate current for three different values of plate potential, the filament current being the same in all cases. It is to be noted that the variation of plate current with grid potential is not linear at all times, but that the "characteristic" graphs are curved at their upper and lower portions. This is a characteristic of vacuum tubes which is very valuable, as will be seen more clearly later on. The graph of grid potentials plotted against plate current is, therefore, called a "characteristic curve."

Relay Action

The action of a grid may be compared to that of a telegraph relay, schematic circuit of which is shown in Fig. 17. The armature of the relay is

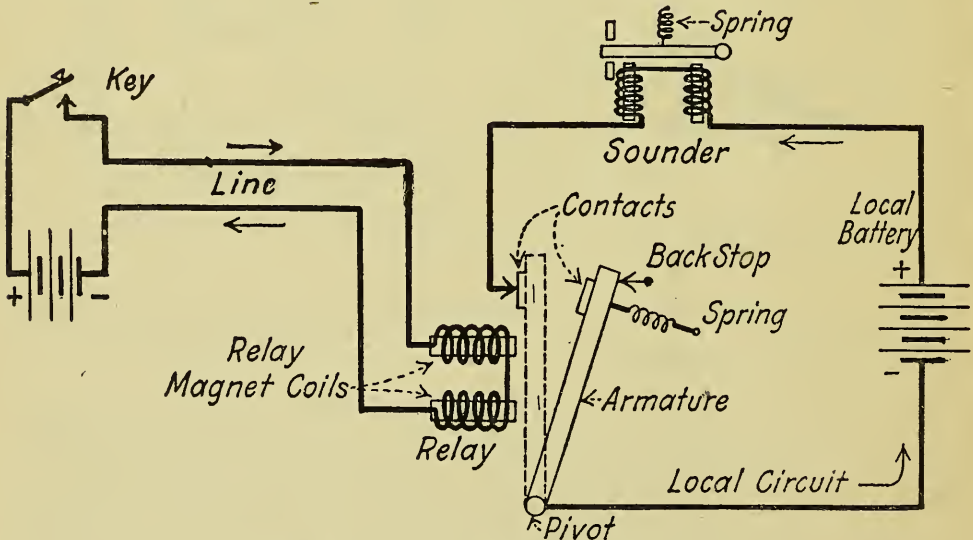

Fig. 17—Circuits of telegraph relay.

magnetically attracted over toward the poles of the electromagnets when the key in the line is closed and current flows through the magnet coils. When the armature is attracted, a

contact is made and a local circuit through a battery and a telegraph sounder is closed. The potential applied to the terminals of the magnet coils may be very small but when the contact is closed a comparatively large current is allowed to pass through the sounder coils and operate the sounder. A relay is then a device which allows a small cause to produce a large effect. In the case of the vacuum tube, the grid is placed much closer to the filament than is the plate. Small potentials when applied to the grid therefore have a larger effect upon the plate current than they would if applied to the plate. The vacuum tube is, then, a relay. Its grid is comparable to the armature of the telegraph relay and the plate circuit of the tube is comparable to the local sounder circuit. The very interesting feature of the vacuum tube is, however, that it has no moving parts. It is true that the electrons move, but they have no weight (are not affected by gravity) and cannot be considered as *parts* of the tube. As far as can be seen, no action takes place within a tube except the heating of the filament to produce light.

Rectification

In Fig. 18 a generator of alternating E.M.F. is connected into the grid circuit in place of the battery of Fig. 15. Referring now to Fig. 19, the normal potential of the grid is assumed to be the same as that of the filament, that is, it is zero with respect to the filament. A certain steady value of plate current then flows, depending upon the plate potential and filament current. This may be called the "normal" value of plate current. The alternating potentials applied to the grid circuit by the generator cause the grid to alternately become positive and negative with respect to the filament. When the grid is positive the plate current increases above the normal value. When the

grid is negative the plate current decreases below the normal. There are variations or alternations of plate current above and below this normal value which are in step with the grid potential variations. Note particularly, however, that the increases are, in this particular case, larger than the decreases. That is, that equal variations of grid potential cause unequal variations of plate current. This being the case, the average value of the

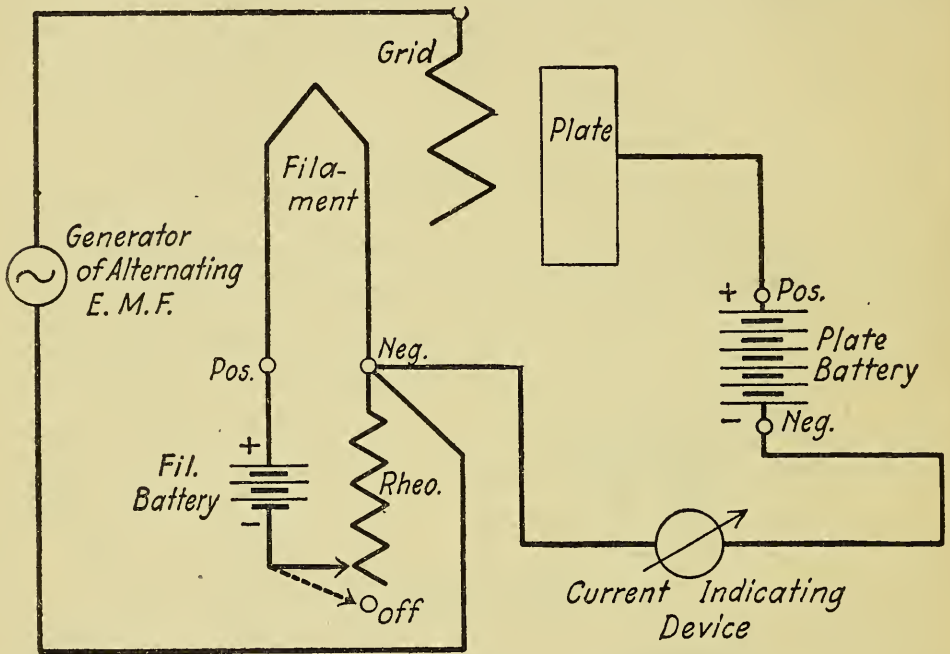

Fig. 18—Continuous variations of grid potentials.

plate current is at every instant greater than the normal value. If the generator were started and stopped periodically this average value would rise when the generator is running and fall back to normal when the generator is momentarily stopped. There would then be periodical increases and decreases of average plate current in step with the starting and stopping of the generator. As far as this average value is concerned there appears to be what is called a "rectification" of the more rapid plate current variations. This is "apparent recti-

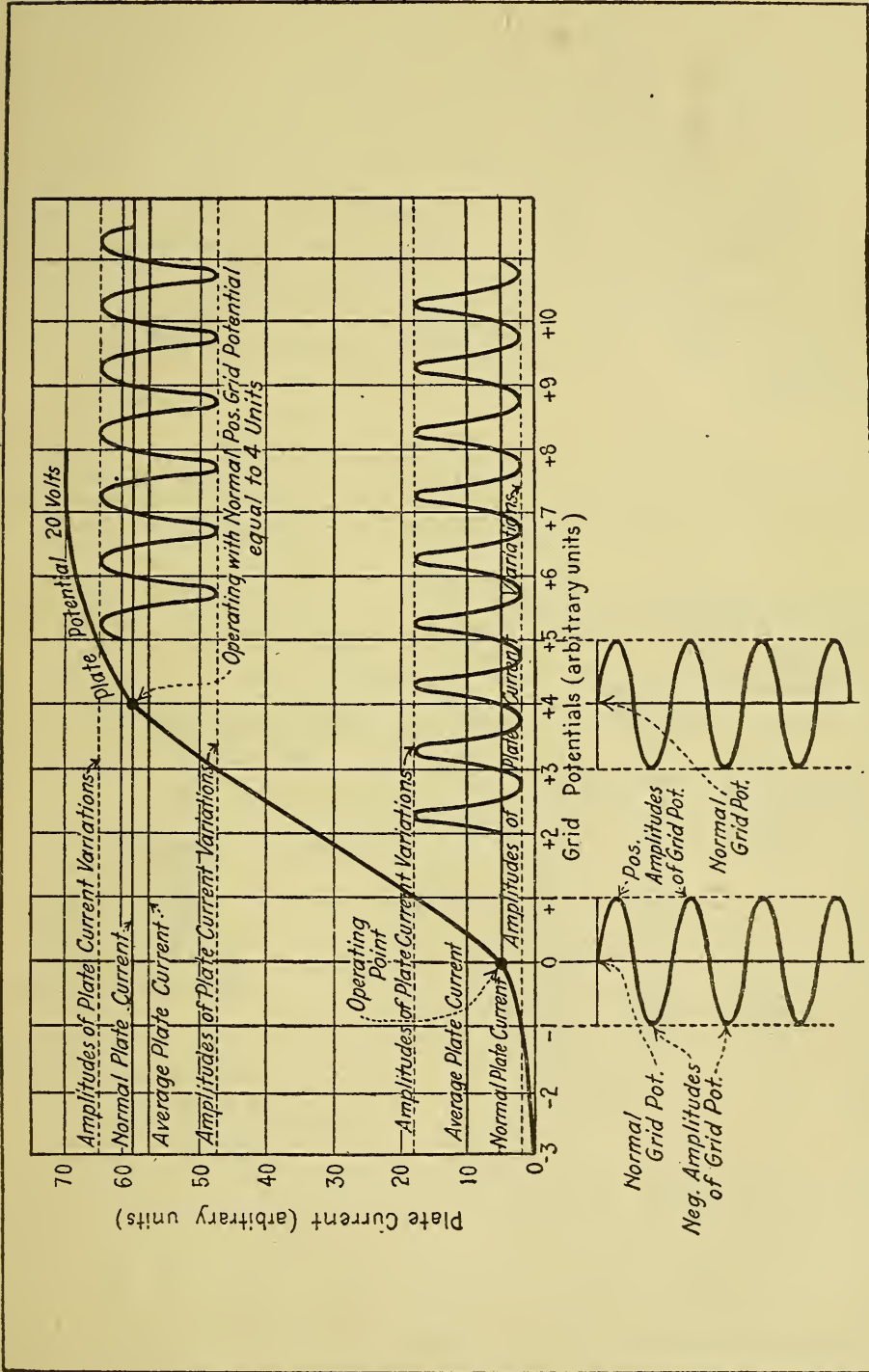

Fig. 19—Variations of plate current with variations of grid potential.

fication" of the plate current. Coincident with this action there is also an actual rectification of the grid current. That is, when the grid receives a positive charge from the generator it attracts electrons to itself and a current flows in the grid circuit. But when the grid receives a negative charge it repels electrons and no current can flow in the grid circuit. The action of the grid therefore changes the alternating current which would otherwise flow under the influence of applied alternating E.M.F. into a pulsating current. This is *actual* rectification.

If, by means of a grid battery (Fig. 20), there is a certain normal positive potential applied to the grid, the normal plate

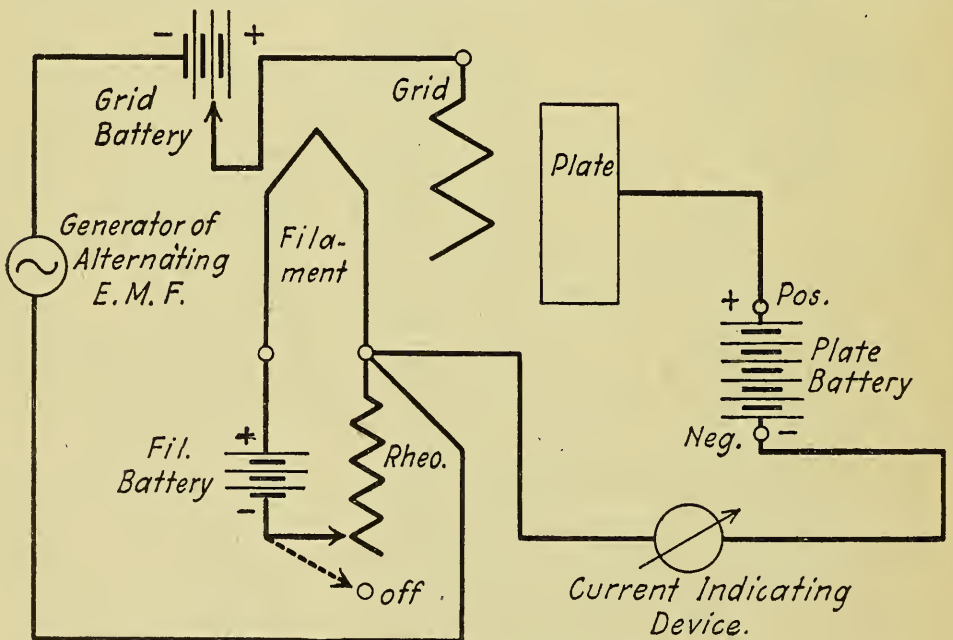

Fig. 20—One method of applying a desired normal grid potential.

current is increased to a greater steady value. In this case the same equal variations of grid potential produced by the generator alternately increase and reduce the positive potential

on the grid. This again causes unequal variations of plate current above and below the new normal value, but the decreases are greater than the increases. The variations are, however, still in step with the grid potential variations. Since a grid current is always flowing, there is no actual rectification of grid current but only an apparent rectification. There still is, nevertheless, apparent rectification of the plate current. It is interesting to note that both the more rapid variations of plate current and the slower variations of average plate current may take place in the circuit at the same time if the generator is periodically started and stopped. Under favorable conditions currents of both the higher and lower frequencies may flow in the plate circuit.

It is a characteristic of vacuum tubes that the increase and decrease of plate current with variations of grid potential is not linear. This has been previously mentioned, but it may be pointed out here that this very characteristic may be made use of in operating the tube as a rectifier. Straight lines drawn to indicate values of grid potential and plate current are seen, in Fig. 19, to cross each other on the graph indicating the relation between the two. If two such lines are drawn to indicate the normal grid potential and the coincident normal plate current, the point where they cross on the characteristic curve may be called the "operating point," since variations in both take place about this point. It is obvious, therefore, that the operating point may be shifted at will by the application of the required normal grid potential.

In order to secure apparent rectification of plate current variations it then becomes necessary to have the operating point on either the upper or lower bend of the characteristic curve. It is most always brought to the lower bend to avoid grid current flow and very high values of plate current which add nothing

to the efficiency of the tube, but actually result in poorer operation.

With the characteristic curve of Fig. 19 a grid current will flow in the tube at certain times because the grid potential is allowed to become positive periodically even though the operating point is on the lower bend of the curve.

All tubes, however, do not have the same characteristics and in some cases it might be necessary to apply a normal negative potential to the grid to bring the operating point to the lower bend of the curve. If, then, the applied alternating potentials never exceed this value of negative potential, no grid current will flow at any time. There is no rectification of grid current, but there is still apparent rectification of plate current.

In the next chapter the practical application of the rectifying action to radio reception is brought out.

CHAPTER III

THE VACUUM TUBE DETECTOR

The telephone receiver—Simple detection—Detection with grid condenser—Effect of gas in a detector tube—Heterodyne action or the production of beats.

The Telephone Receiver

When ether waves are produced at a distant transmitting station and, in turn, cause oscillating electric current to flow in a receiving antenna, it is necessary to provide some kind of an indicator which will make the presence of these oscillations manifest to one of the senses. It is customary to translate these

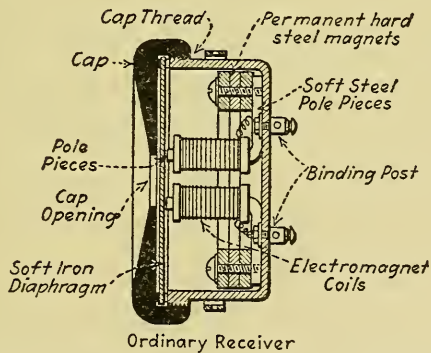

Fig. 21—Construction of a typical telephone receiver.

oscillations into audible sound so that signals may be perceived by the sense of hearing. A telephone receiver, the construction of which is shown in Fig. 21, has two coils of wire, each wound in many layers around an iron core to produce two electro-magnets. A metal diaphragm is so supported that it may be attracted by the magnet poles or released, depending upon the strength of magnetism in the poles. An increase of

electric current through the magnet windings causes the diaphragm to be attracted and a decrease of current causes it to be released, because the strength of magnetism is thereby increased and decreased. If the diaphragm is attracted and released periodically it is caused to vibrate, and if the mechanical frequency of vibration (number of attractions and releases per second) is somewhere between 15 and 15,000 vibrations per second, the air waves thereby created will produce audible sound in the human ear. The more rapid the vibrations are, the higher the pitch of the sound which is produced. The telephone receiver is a very sensitive indicator or translator and is very extensively used in radio work for this purpose.

Simple Detection

In Fig. 22 there is an antenna circuit containing a coil and a condenser, both of which are variable to provide for the tuning of the circuit. The opposite terminals of the coil are connected to the grid and filament of a vacuum tube as shown. Suppose that continuous oscillations are present in the antenna and, therefore, flowing in the coil. If the antenna is in resonance with a transmitting antenna, these oscillations will be of maximum amplitude and will set up radio frequency oscillations of potential at the coil terminals, which will also be of maximum amplitude. Now, the coil terminals are connected to grid and filament so that the oscillating potentials must be applied to the grid and filament of the tube. The oscillating potentials at the coil terminals have now replaced the alternating E.M.F. produced by the generator of Fig. 18, and their frequency is very much higher than the alternating E.M.F. then considered. The plate current variations now take place at radio frequency instead of at the frequency of generator

E.M.F. or potential variations. Fig. 19 may be referred to again and the operating point considered to be on the lower bend of the curve. Equal variations of grid potential at the radio frequency produce unequal variations of plate current at radio frequency. Now, radio frequency is always entirely beyond the frequency range of audible sound, so that if the tele-

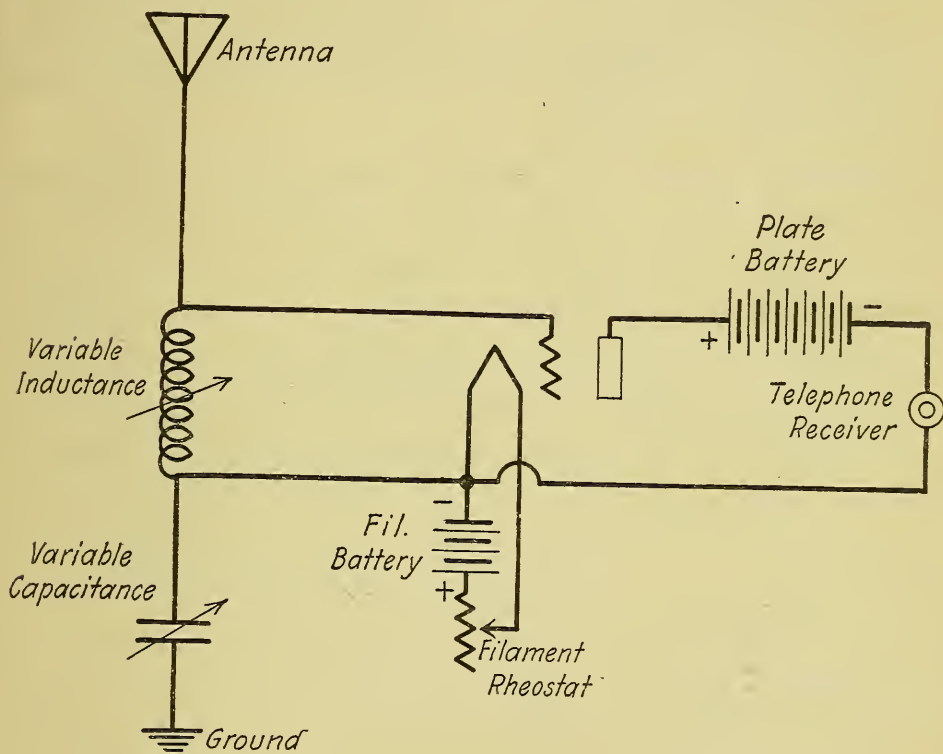

Fig. 22—Simple detector circuit.

phone receiver diaphragm vibrates, it does so at a rate which is too high to produce sound. As a matter of fact, however, the diaphragm does not vibrate at such frequency because of its weight and because very little current of radio-frequency can flow through the magnet windings. It must be remembered that the reactance of a coil (or coils) increase with the frequency and with the insertion of an iron core. The react-

ance of an ordinary telephone receiver winding is very high indeed to currents of radio-frequency. The current that does flow through the receiver windings is the average value of direct current in the plate circuit. In the case under consideration this average current is higher than the normal value and remains constant so long as the amplitudes of the antenna oscillations do not vary. Therefore, when unmodified undamped waves are radiated by a transmitting station no sound is produced in a telephone receiver at the receiving station with a simple detector circuit.

Suppose, however, that damped waves are radiated by the transmitting station. In this case it will be remembered that there are groups (or trains) of oscillations produced in the receiving antenna, each composed of radio frequency oscillations whose amplitudes decay from a maximum value to zero periodically. The grid and filament circuit of Fig. 22 then being still connected across the antenna coil, radio-frequency potential variations are applied to the grid, whose amplitudes decay from a maximum to zero during each group of oscillations, as shown in Fig. 23. As also shown in the graph of this figure, the radio-frequency plate current variations also decrease in amplitude during each group or train of oscillations and there is a variation in the average plate current which rises and falls once for each oscillation train. If the frequency of the oscillation trains is within the limits of audibility (15 to 15,000 per second) the frequency of the variations of *average* plate current is also an audible frequency or, as it is called, an "audio-frequency." Current variations of such comparatively low frequency pass through the receiver windings and cause the diaphragm to vibrate and to produce sound waves of the same frequency which, being audible, are heard by the human ear. The sound heard depends then upon the frequency of the oscil-

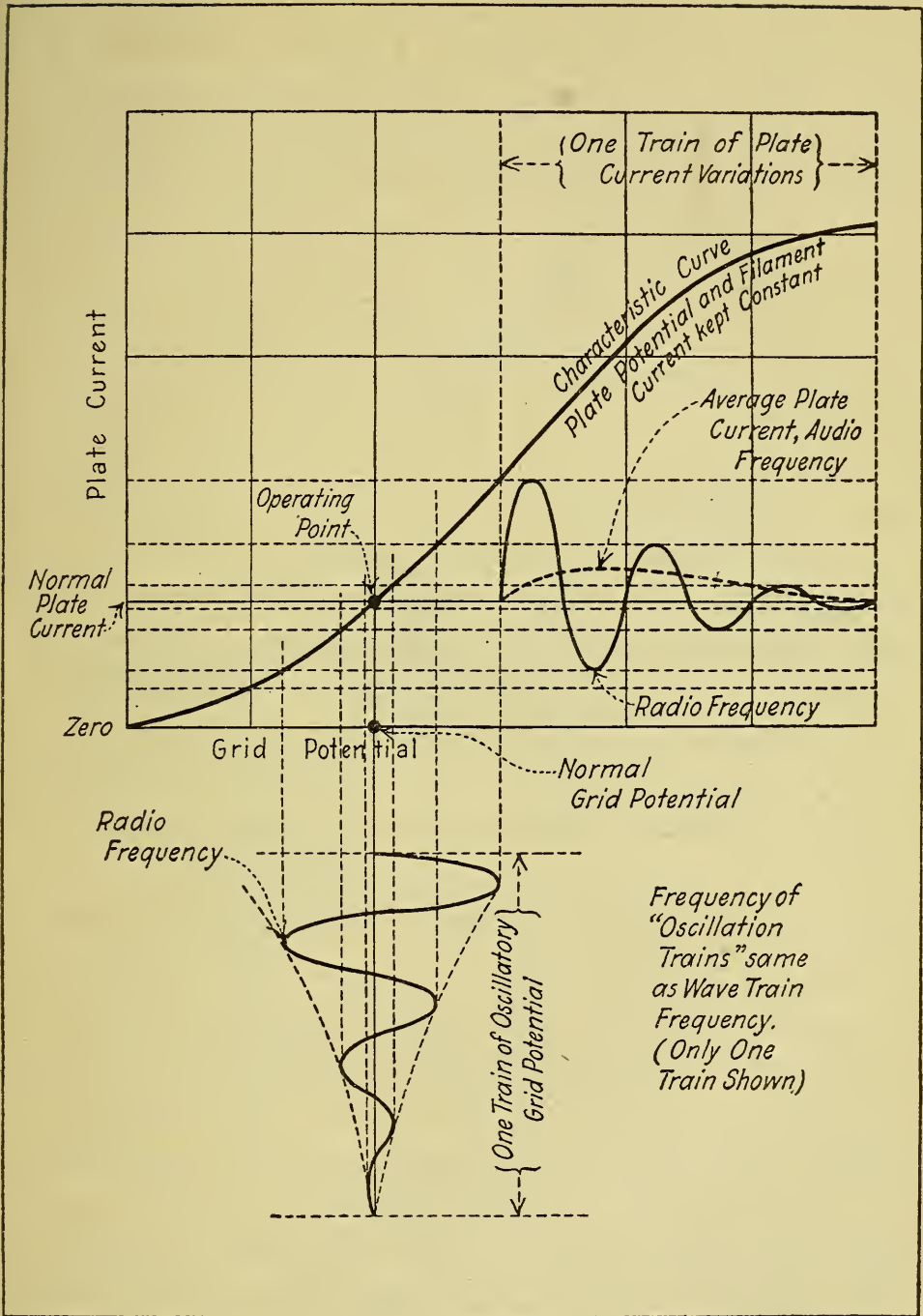

Fig. 23—Rectification effect in plate current with damped grid potential variations.

lation trains and increases in pitch with that frequency. Suppose a case in point is considered. There is a transmitter at a distant station which creates in the transmitting antenna oscillations whose frequency is 1000 per second. The transmitter could be a 500 cycle synchronous rotary gap or quenched gap spark transmitter. Ether wave trains are set up whose frequency is also 1000. These ether waves cause trains of oscillations in the receiving antenna, variations of average plate current, receiver diaphragm vibrations and, finally, sound waves, all of the same frequency, 1000 per second. If the distant transmitter were a 240 cycle set, ether wave trains of 480 per second would be created and the frequency of the sound waves produced by the receiver diaphragm would be 480 per second. The pitch of the tone would be higher in the first case than in the second, although both tones would be musical. Damped oscillations, being modified radio frequency oscillations, produce audible sound in a telephone receiver.

If the undamped oscillations generated by a transmitter are modified by auxiliary apparatus in such a manner as to vary the amplitudes of the radio-frequency oscillations at an audio-frequency rate (frequency with the limits of audible sound), air waves of the same audible frequency will be produced by the receiver diaphragm. The radio-frequency oscillations are molded into groups and that group frequency is selected which will give the most pleasing pitch of tone in the telephone receiver. Such a process of molding is called "modulation." Fig. 24 illustrates the effect of modulated continuous oscillations in a simple detector circuit. The group frequency is maintained at a constant value, usually, so that the tone does not change at any time. Different transmitting stations may, however, select different group frequencies and therefore produce tones in a receiver which differ from each other. A trans-

mitting station can then often be identified by its tone frequency.

A radio-telephone transmitter must use a generator of continuous radio frequency oscillations but, in this case, the radio

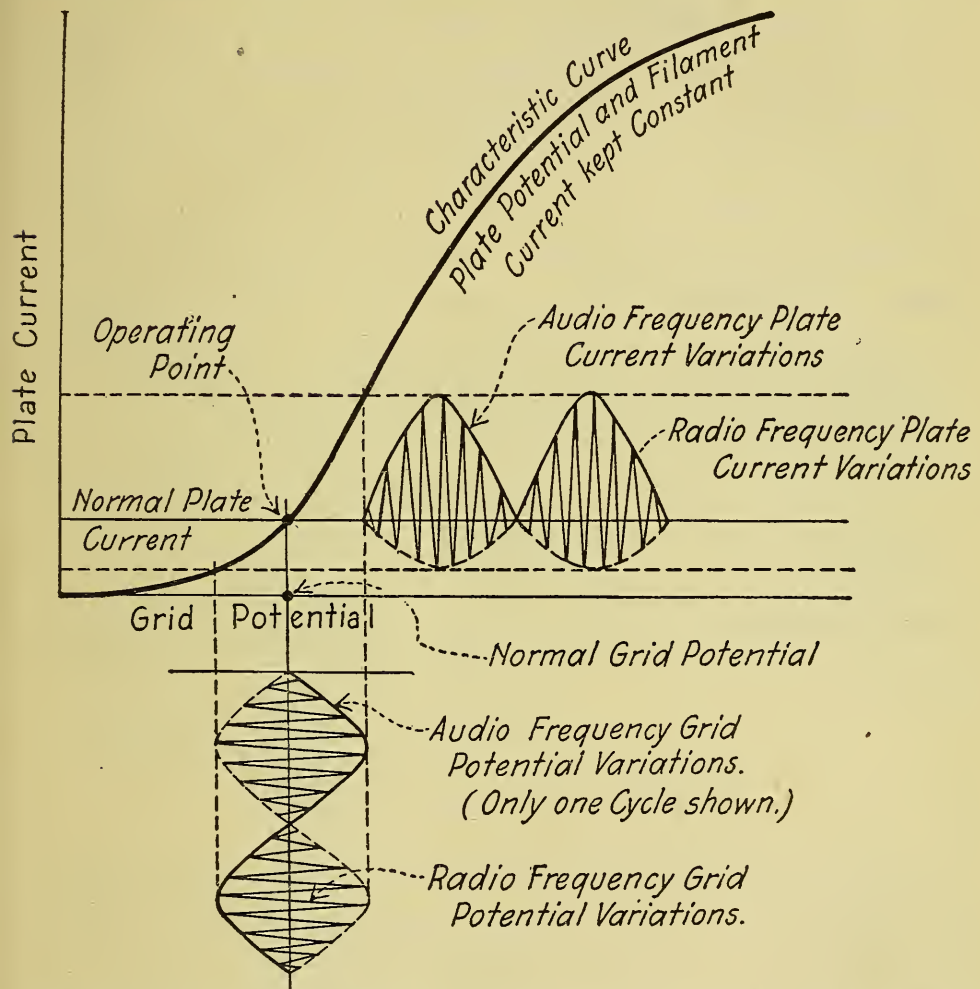

Fig. 24—Detection of modulated continuous oscillations at a constant group frequency.

frequency current amplitudes are not always varied at the same audible frequency as is usually the case with modulation for telegraphic purposes. The frequency of the sound waves created by the human voice averages around 800 per second, but constantly increases and decreases with the pitch of tone. Every change in inflection of the speaking voice and every change in

tone of the singing voice means a change in the frequency of the air waves created. In the case of music produced by various instruments, every change in tone also means a change in air wave frequency. In the operation of a radio-telephone transmitter, devices are provided which will cause the originally generated undamped radio frequency oscillations to be molded or modulated constantly in amplitude at constantly varying tone frequency. The constant changes in tone (group) frequency therefore produced in the receiving antenna cause constantly varying changes in the current flowing through a telephone receiver of the simple detector circuit. The result is, of course, air waves and sound created by the receiver diaphragm of constantly changing frequency in step with the frequency of the sound waves acting upon the distant transmitter. Fig. 25 gives an idea of how this is accomplished in the receiving circuits.

In all of the above considerations it is, of course, understood that the receiving antenna must be tuned to the radio frequency oscillations no matter what the group or tone frequency may be.

Detection with Grid Condenser

In the case of simple detection there may be actual or apparent rectification of grid current, depending upon the normal grid potential. If a small condenser is connected into the grid circuit close to the grid, however, the rectification of grid current is actual. There is also apparent rectification of the plate current variations. The mode of functioning is somewhat different, however, when a grid condenser is used.

Assume that, due to resonance with a transmitting antenna, there are damped radio frequency oscillations of maximum possible amplitudes induced in the receiving antenna. Radio

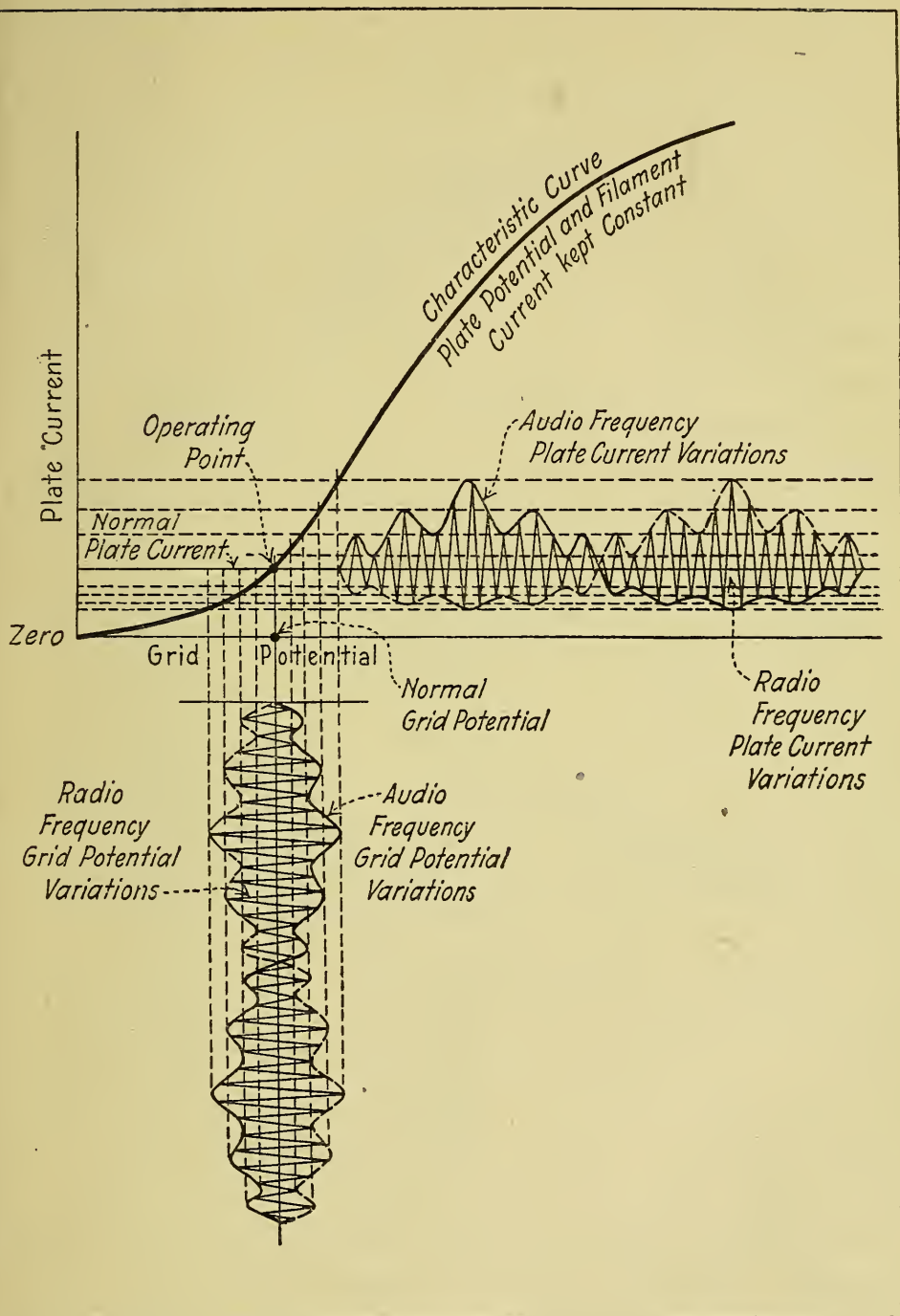

Fig. 25—Detection of voice modulated continuous oscillations at a varying group frequency.

frequency alternating potentials are applied to the grid through the grid condenser. When the grid receives a positive charge from the circuit it attracts electrons to itself, a grid current flows and the plate current is momentarily increased, since the operating point is now assumed to be on the straight portion of the curve. (Fig. 26). The grid then receives a negative charge, repels electrons, no grid current can flow and the plate current is reduced. But, when the grid was positive and electrons were attracted to it these electrons were trapped on the grid because of the "blocking" action of the grid condenser. When, during succeeding alternations of the applied potential, the grid receives a positive charge more electrons are attracted to the grid and are trapped. During one group of oscillations then, the grid accumulates electrons, its negative potential increases and the average plate current decreases. (Electrons are negative charges.) It may be pointed out here that the normal potential of the grid with respect to the filament is always zero. During a group of oscillations the negative charge on the grid is built up to a comparatively large value and, unless the charge leaks off of the grid, the grid potential will not be zero at the beginning of the next group of oscillations. During the group of oscillations just considered the operating point has slid down the characteristic curve. If this negative grid charge does not entirely leak off, the next group of oscillations will cause the negative grid potential to increase and the operating point to slide still further down the curve. It is obvious that the cut-off grid potential might be reached and the plate current stopped entirely. When this happens the tube is said to be "blocked" or "choked." It is paralyzed until the grid charge is allowed to leak off, for example by placing the fingers on the grid terminal. It is quite necessary, therefore, to provide a path

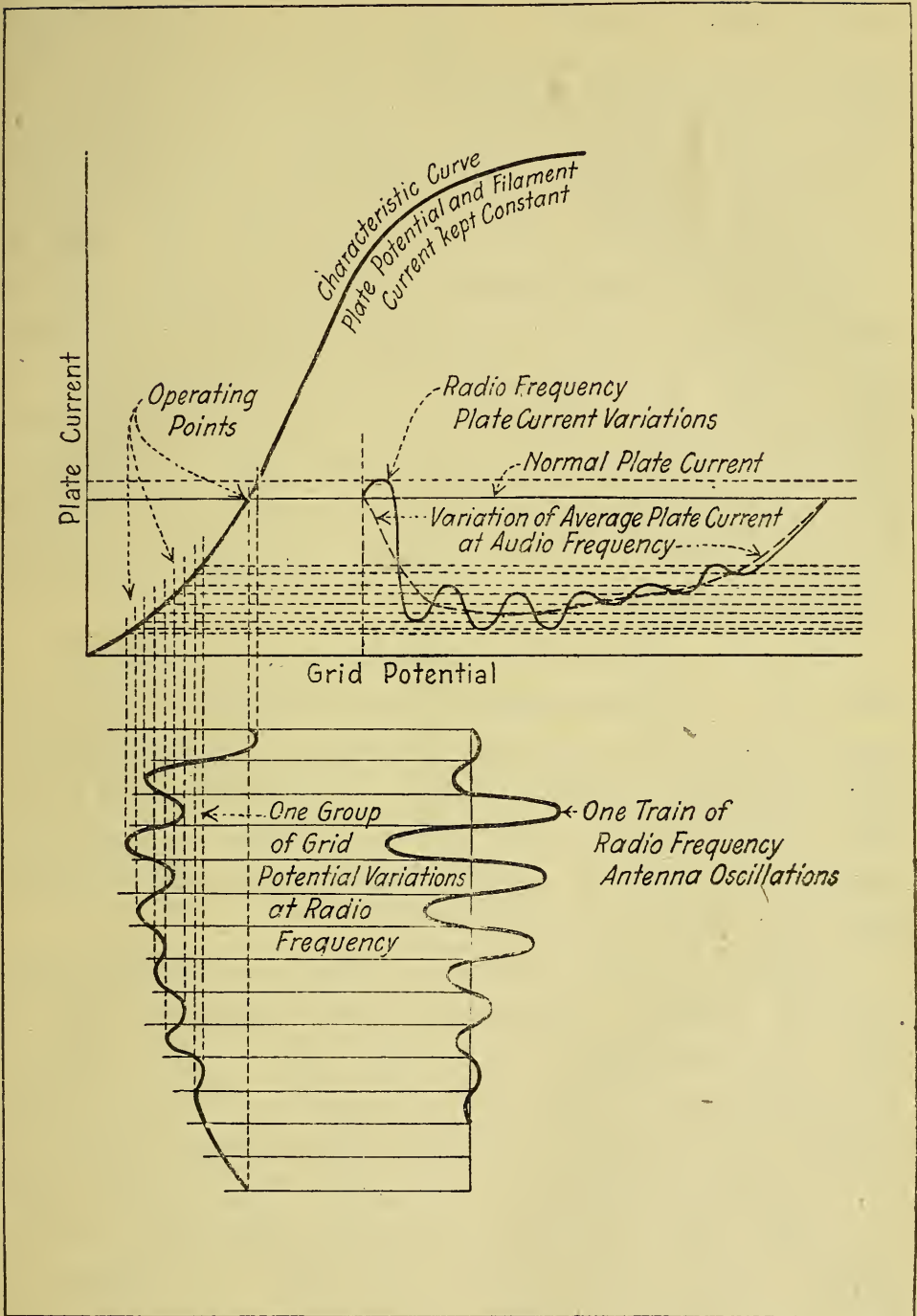

Fig. 26—Rectification or detection of damped oscillations with a grid condenser.

through which the negative charge may leak when it becomes large, so that the grid potential may be returned to zero and the plate current to normal in time for the next group. This may be accomplished by connecting a resistance called a "grid leak resistance" across the grid condenser terminals or directly between the grid and the filament. The value of resistance must be high enough to prevent any great flow of current through it until the maximum charge has accumulated upon the grid. It should not be too high, however, because the charge would not then leak off quickly enough, but might accumulate until it leaks off through the glass walls of the tube, the dielectric of the grid condenser or the vacuum space between filament and grid. This might cause a thumping noise in the telephone receiver.

In the next section tubes containing gas are described. If such a tube is used as a detector the negative grid charge may leak from the grid to the filament because of the comparatively good conducting path then offered. If the gas content of the tube is high enough no grid leak is necessary. Modern gas content tubes, however, usually require a grid leak resistance when used with a grid condenser.

In Chapter V various practical circuits are described which show the schematic connections of grid condensers and grid leaks. No grid battery is ever needed with a grid condenser. The rectification of plate current oscillations does not depend entirely upon the location of the operating point because it is the cumulative effect of the negative grid charge which causes the plate current decrease during each group of oscillations. As a matter of fact, however, it is desirable to have the normal operating point on the straight portion of the curve so that the decrease of grid potential caused by accumulation of negative charge will produce the greatest

possible change in plate current. Reference to Fig. 26 will make all these points more clear.

The effect of the grid condenser does not change the relation between the group frequency of the antenna oscillations and the group frequency of the plate current variations. The latter is still the same as the former and the frequency of air waves (pitch of sound) is still the same as the group frequency of oscillations in the antenna circuit. The detector with grid condenser may be used for the reception of damped waves, modulated undamped waves for telegraphic purposes or voice modulated undamped waves as in radio-telephony. Later on it will be shown how straight undamped waves may also be detected by modifying the radio-frequency oscillations in the receiving circuit.

Effect of Gas in a Detector Tube

Under "Tube Construction" in the preceding chapter it was stated that some tubes, called "soft" tubes, contain a small amount of gas. This gas is rarefied, of course, since the vacuum within the tube is still comparatively high, although not as perfect as it might be made. Electrons are not matter in any shape or form, but gas is most certainly a form of matter. Therefore if there is gas within a tube, the tube space is not absolutely devoid of matter, except for the electrodes, but has matter between the filament, grid and plate. Its action also cannot, therefore, be exactly like a very high vacuum, or "hard," tube.

The smallest possible particle of gas is called an "atom." It is too small to be seen but, nevertheless, has weight because it can be acted upon by gravity. Electrons do not have weight because they cannot be acted upon by gravity. Each atom of gas has a central nucleus which carries a positive charge of elec-

tricity. This nucleus is surrounded by electrons (negative charges) so that, normally, the sum of all the negative charges of the electrons equals the positive charge of the central nucleus. If an electron projected at high velocity from a filament collides with an atom of gas, it may very easily cause one or more electrons to be torn away from the atom. When such a thing occurs, the positive charge of the atom over-balances its remaining negative charges and it acts like a positive charge of electricity. In this condition it is called an "ion." That is, an atom is known as an "ion" after it has lost one or more electrons. It is quite conceivable that if there are thousands of electrons projected from the filament per second, all at high velocity, many collisions might take place between them and the gas atoms. Many ions would then be created. Such action is called "ionization by collision." Now, under the influence of a positively charged plate, the electrons emitted by the filament and those set free by collision move toward the plate and are attracted to it at a rate depending upon its potential. The ions are repelled by the plate toward the filament. Suppose that electrons are not projected in sufficient numbers per second from the filament to equal the rate of attraction of the plate. If additional electrons are produced by collision, they may make up the deficiency and cause the plate current to be increased without the increase of filament temperature. Care must be taken, however, to keep the plate potential below the value which causes too large plate current. When too much plate current flows there will be a visible blue glow inside the tube and the plate current will not be appreciably affected by the grid potential variations. The result is very erratic action of the tube and a decrease in volume of sound from the telephone receiver. The "soft" tube is more sensitive as a detector than the "hard" tube, but it has its disadvantages.

The most marked disadvantage is probably the critical adjustment of filament temperature and plate potential necessary to satisfactory operation. Another is the shortened life of the tube caused by the bombardment by the comparatively heavy ions which are driven against it when they are repelled by the plate.

Heterodyne Action, or the Production of Beats

It has been pointed out that unmodulated (unmodified) undamped radio frequency oscillations will not produce sound in

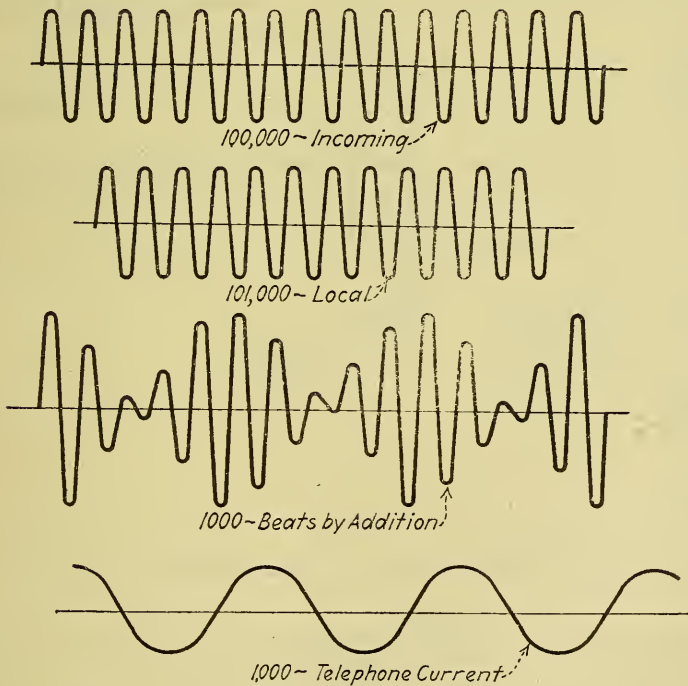

Fig. 27—The principle of heterodyne action.

a telephone receiver. If, however, oscillations of a different frequency are generated locally and forced to flow in an antenna circuit there is an interaction between the two frequencies which produces oscillations of a third frequency equal to the numeri-

cal difference between the other two. The third frequency must then, of course, be lower than either of the other two. This action is called "heterodyne action" and the oscillations of the third and lower frequency are called "beats." The curves of Fig. 27 show this graphically. There are, in this case, oscillations induced in the antenna circuit (by a distant transmitter) whose frequency is 100,000 cycles per second and oscillations

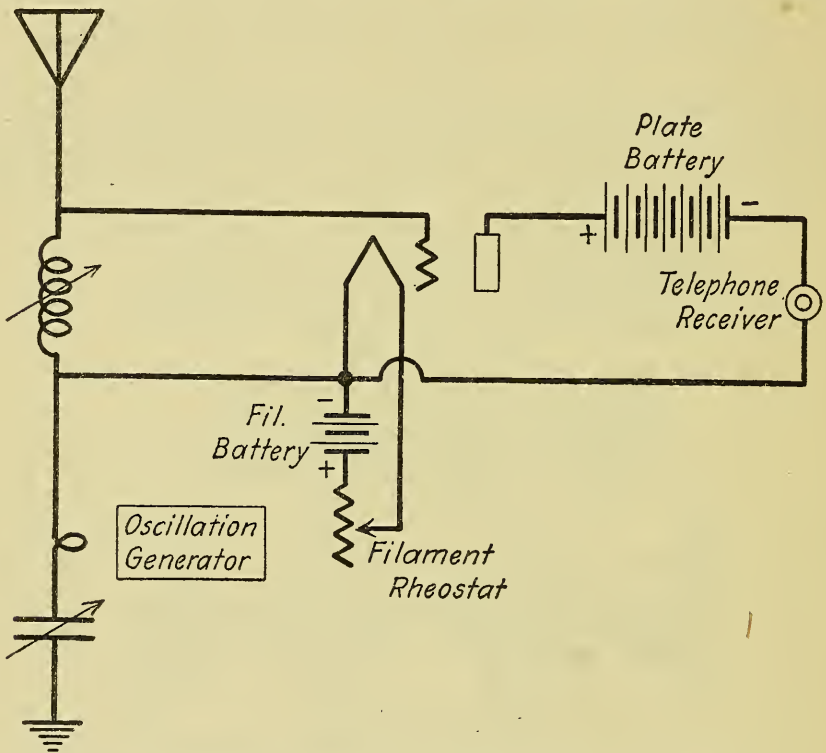

Fig. 28—Schematic circuit for the production of beats.

produced by a local oscillation generator whose frequency is 101,000 cycles per second. Both are radio frequencies and neither by itself produces any audible response in the telephone receiver. Now, the local oscillations are forced to flow in the antenna circuit although the latter is not tuned to them. This is because of a strong inducing action of the local generator upon the antenna circuit. The amplitude of the forced oscilla-

tions (of 101,000 cycle frequency) in the antenna circuit is not maximum, but that makes no difference. The frequency of the third set of oscillations in the antenna circuit is 1000 cycles per second (within the limits of audible sound) and will cause the average plate current to vary or pulsate 1000 times per second and the telephone receiver diaphragm to vibrate at the same frequency. The sound waves produced are, then, at the rate of 1000 per second and the same tone is heard as would be if the transmitter at the distant station were a 500 cycle spark set. In this manner the undamped waves are modified by heterodyning at the receiving station and made to produce an audible response in the telephone receiver.

Various schematic circuits are illustrated in a following chapter, which show how connections may be made to produce this heterodyne action. The local oscillations may be generated by an entirely separate generator, as in Fig. 28, or the detector circuit may be slightly changed so that it acts as an oscillation generator at the same time that it acts as a detector.

CHAPTER IV

THE VACUUM TUBE AMPLIFIER

General characteristics—Audio frequency amplification—Radio frequency amplification—Radio frequency regenerative amplification—Autodyne production of beats.

General Characteristics

Because of the relay action of a tube, a certain amount of amplification takes place even when the tube is functioning as a detector. Amplification may be said to be an inherent property of all vacuum tubes.

If a steady potential is applied to the grid which brings the operating point to a position on the straight portion of the characteristic curve, equal variations of grid potential will cause equal changes of plate current. No distortion of plate current is then caused, even with damped oscillations, and its variations are not only in step with the antenna oscillations but its amplitudes are proportional to the amplitudes of antenna oscillations at every instant. See Figs. 29 (a) and (b).

If radio-telegraph signals only are received, distortion of the oscillating plate current is not such a serious drawback. But when radio-telephone speech and music are received it is imperative that no distortion takes place or the sounds heard may not be accurate reproductions of the sounds at the transmitting station. They may, in fact, be so greatly distorted that they are extremely difficult to understand or absolutely unintelligible. An ideal amplifier is, then, one in which the antenna current is amplified without distortion regardless of the combination of frequencies involved.

By this time it has probably become self-evident that the volume of sound produced in a telephone receiver depends upon the amplitudes of the diaphragm vibrations back and forth.

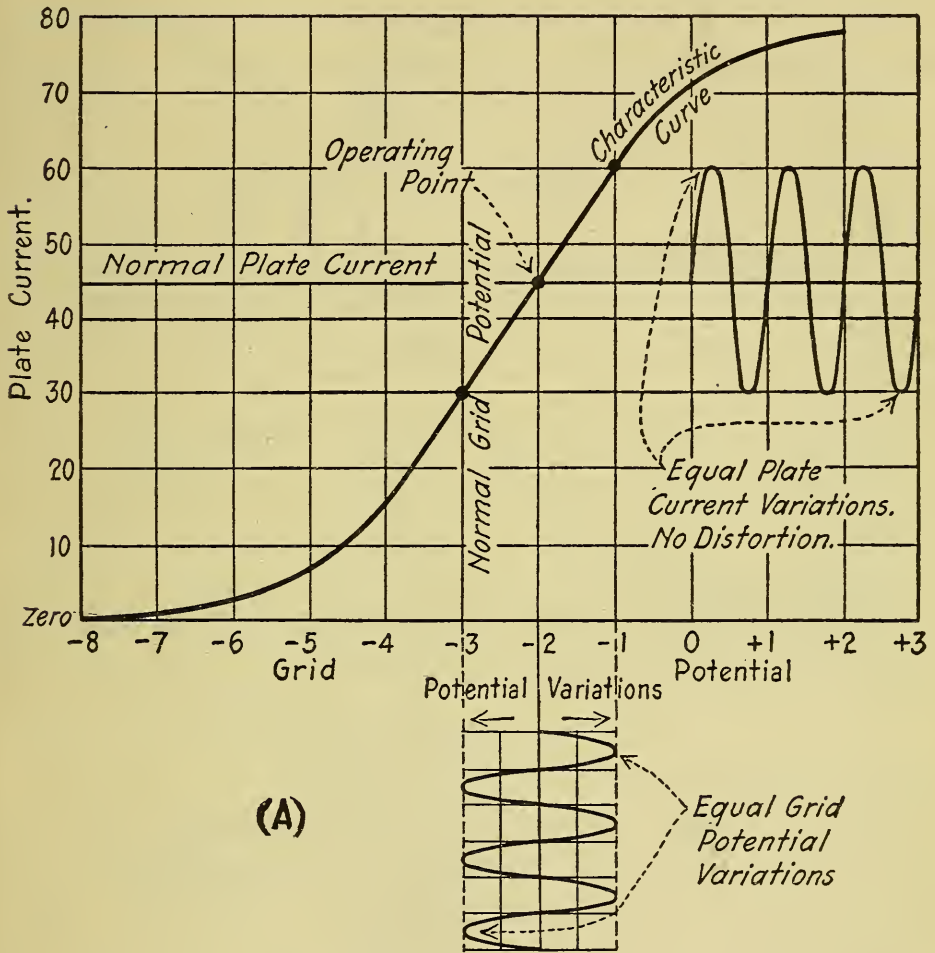

Fig. 29 (a)—Amplification of continuous oscillations.

These amplitudes in turn depend upon the amplitudes of the audio-frequency plate current variations passing through the receiver magnet-coils. The coils smooth out the variations somewhat, but their amplitudes depend nevertheless upon the amplitudes of the oscillations in the antenna circuit. Because of inherent amplification these audio-frequency current ampli-

tudes in the plate circuit are usually larger than those in the antenna. They may not, however, be large enough to create the

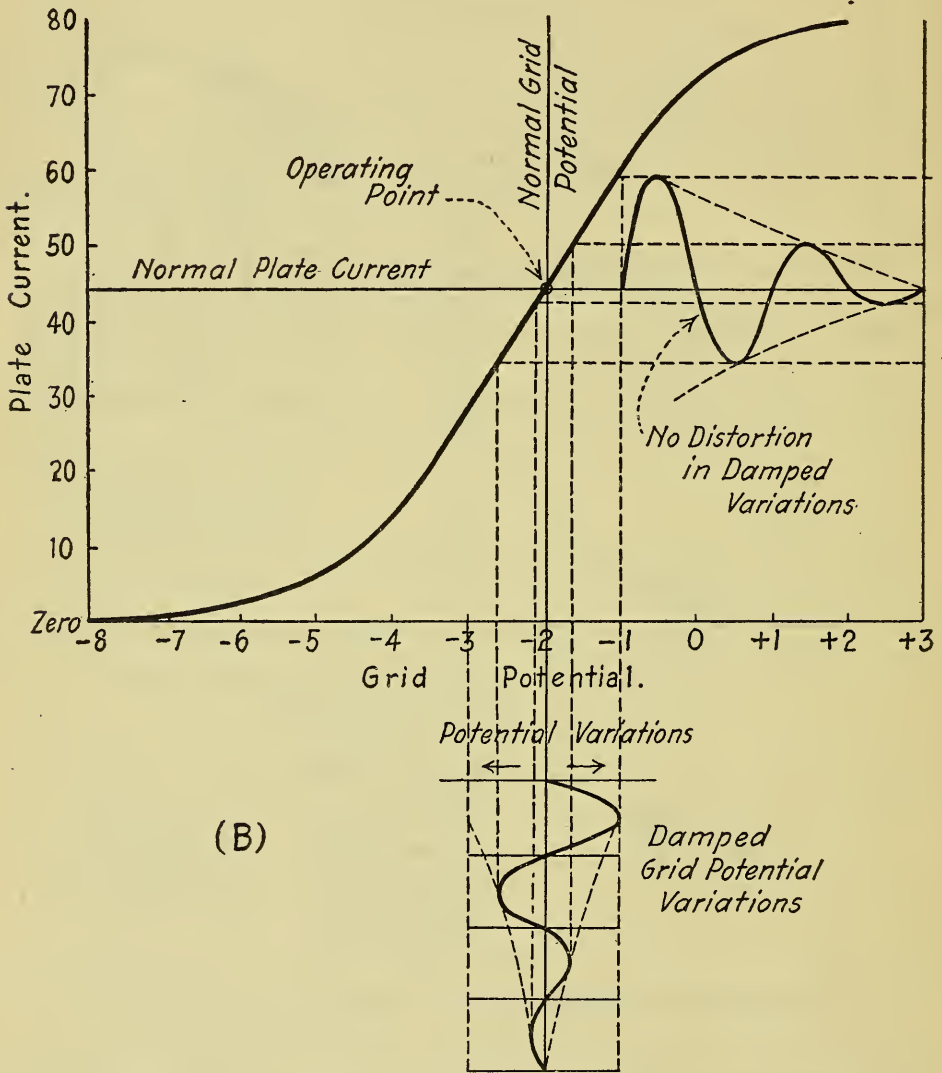

Fig. 29 (b)—Amplification of damped oscillations.

desired amplitudes of sound waves and therefore the volume of sound from the telephone receiver. Amplification must then be increased in some manner.

Amplification Factor

It has been stated that if the filament current and plate potential are kept constant, the plate current varies with the grid potential. It is also true that if both filament current and grid potential are kept constant, the plate current varies with the plate potential. There are then two possible ways to vary the plate current when the filament current is constant. But the reason the potential variations due to signals are applied to the grid rather than to the plate is that they have greater effect upon the plate current in the former case than in the latter. There would otherwise be no object in having a grid electrode. The ratio of plate potential variation to grid potential variation required to produce any given change in plate current is called the "voltage amplification factor." For example, if a certain increase in grid potential will produce a certain increase in plate current and it takes an increase of plate potential six times that of grid potential to produce the same increase of plate current, the voltage amplification factor is six.

The value of any given vacuum tube as an amplifier depends upon this amplification factor. In general, all other conditions being equal, the amplification factor of a tube depends upon two things. The first is the relation between the distance of the plate from the filament and the distance from the grid to filament. That is, with a given distance between plate and filament, the closer the grid is to the filament the greater this amplification factor will be. The second is the spacing between the grid wires (or distance between turns). The amplification factor increases with a decrease of spacing and vice versa. Tubes may thus be compared with each other and their relative values as amplifiers roughly judged.

With any given tube, the amplification factor also depends

to some extent upon the plate and grid potentials. It cannot, therefore, be considered as an actual constant. If, however, only the straight portions of characteristic curves are considered the effect of plate and grid potentials upon amplification constant may be ignored.

The value of a tube as an amplifier also depends upon the degree of vacuum and the very "hard" tubes are considered far superior to the "soft" tubes for amplification purposes.

Now, the slope of the grid-potential, plate-current curve depends upon the amplification factor, other things being equal. If this characteristic curve for one tube is steeper than that for another, grid potential variations in the first tube will produce larger plate current variations than will be produced in the second tube by the same grid potential variations. This may be seen by comparing Fig. 30 with Fig. 29 (a). In the case of an amplifier tube it is only the straight portion of any characteristic curve which is of interest, since operation on a bend of the curve would result in unsymmetrical variations of plate current.

Audio Frequency Amplification

If it is desired to amplify the audio-frequency current in the plate circuit of a detector tube, the primary of a small closed core transformer may be connected between the plate and the positive terminal of the plate battery. The secondary of the transformer is then connected into the grid circuit of another tube and the normal potential on the grid of this second tube is so adjusted that its operating point is on the straight portion of its characteristic curve. Usually a certain amount of steady negative potential must be applied to the grid of this amplifier tube to accomplish this result. This may, of course, be done by inserting a grid battery of proper voltage into the grid circuit

and connecting the negative battery terminal to the grid. Another and better method is to include a portion of the fila-

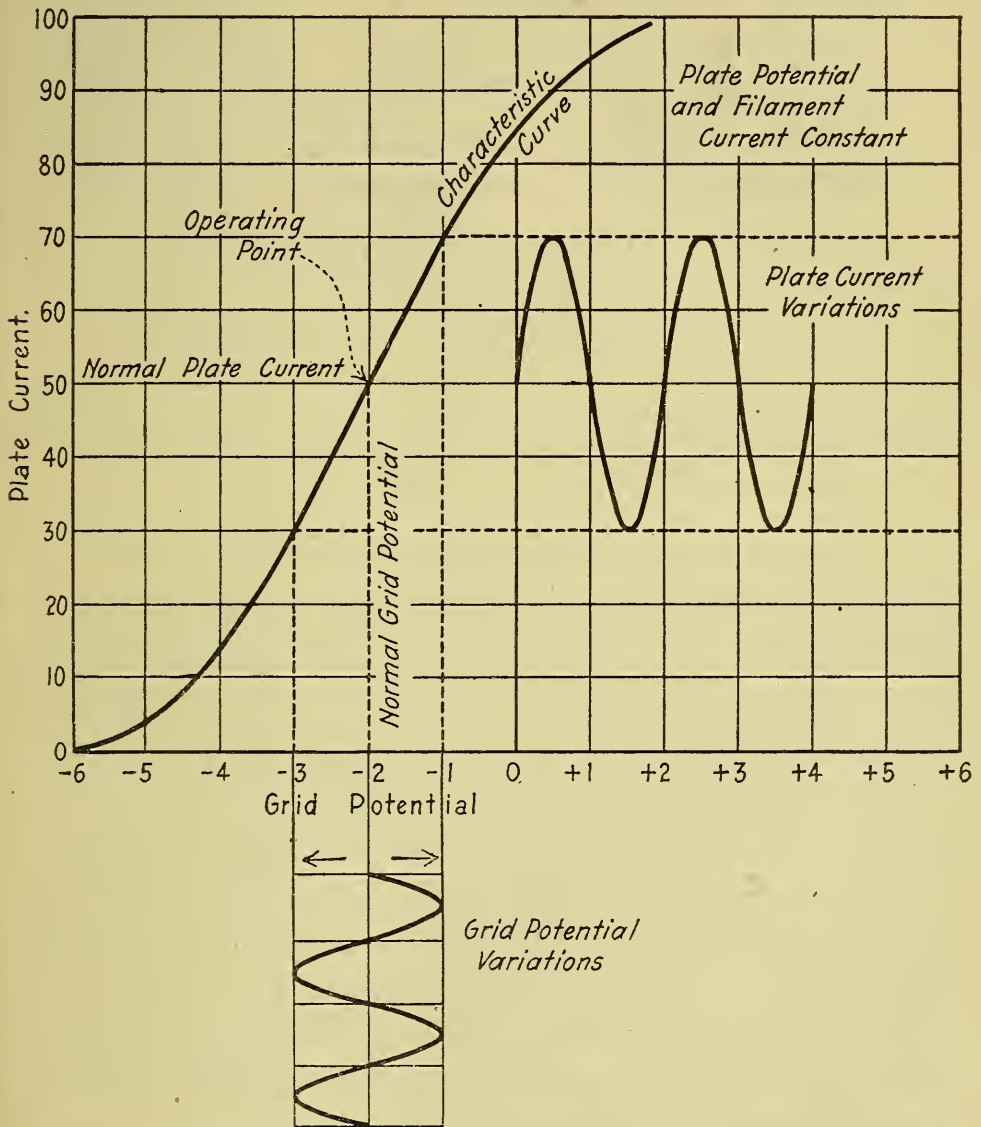

Fig. 30—Amplification of continuous oscillations

ment rheostat resistance in the grid circuit as shown in Fig. 31. This places a negative potential upon the grid which is equal to the potential difference between the points "X" and "Y."

The audiofrequency variations of plate current in the detector tube now cause grid potential variations in the amplifier tube which are larger in amplitude than the grid potential vari-

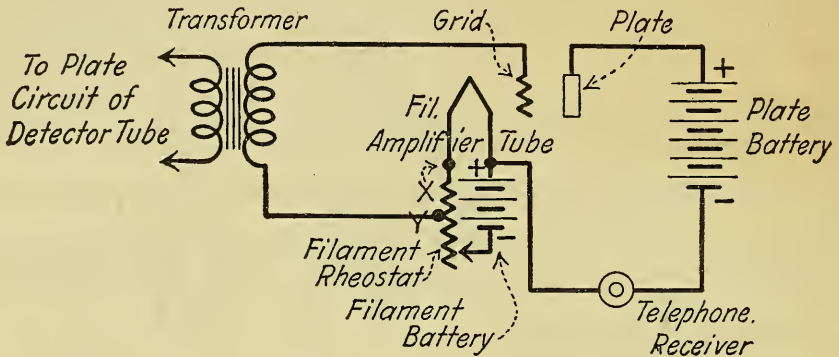

Fig. 31—Customary method of placing a normal negative potential on the grid of an amplifier tube.

ations applied to the detector tube by the antenna oscillations. These variations of amplifier grid potential will be at the audible frequency rate because radio frequency current variations cannot readily flow in the detector plate circuit due to the high reactance of the transformer primary. Audio-frequency currents will then flow in the plate circuit of the amplifier tube and through the telephone receiver. The receiver diaphragm will vibrate with greater amplitude because the current variations are of magnified amplitude and, as a final result, the sound heard in the telephone receiver is louder. This can easily be verified by plugging a telephone receiver into the jack of the detector circuit and then into the jack of the first stage of an audio-frequency amplifier.

If still further increase in audibility (or volume of sound) is required one or more "stages" of amplification may be used in the same manner. Such amplification is referred to as "cascade amplification." Usually two stages of audio frequency amplification (two amplifier tubes in cascade connection) are the

limit, although if care is taken three stages may sometimes be managed.

The signals must, of course, be put through a detector tube and rectified before they are applied to an audio-frequency amplifier. With cascade amplification sufficient current may frequently be secured in the plate circuit of the last tube to operate a relay or a device known as a "loud speaker." If the relay is used, telegraph signals may be sent over a land wire from the radio receiving station to a distant office where another relay opens and closes a local sounder circuit. If the loud speaker is used both radio telegraph signals and radio-telephone speech and music may be reproduced with sufficient volume to be heard considerable distances away from the instruments.

Radio Frequency Amplification

The amplitudes of the grid potential variations in any tube control the audio-frequency variations of average plate current. These grid potential variations of course depend upon the amplitudes of the antenna oscillations. If the antenna oscillations are weak, that is, if the signal is weak, the grid potential variations are also weak (of small amplitude) and a detector tube may not be made to function properly and possibly not at all. This is because the sensitiveness of a detector depends upon the *square* of the potentials applied to the grid by the signal current. For example, if a certain voltage applied to the grid produces a certain change in plate current, twice the applied voltage will produce four times the change in plate current. It is obvious that the amplitudes of the antenna oscillations might at times be too small to operate the detector tube. In this case there would be no amplification of the very weak signal by means of audio-frequency amplification because the signal can not operate the detector in the first place.

When signals are very weak it is then of very great advantage to amplify them before they are rectified. That is, to amplify the antenna oscillations until the potential variations are high enough to operate a detector tube to good advantage. To do this it is necessary to amplify *radio* frequency oscillations *before* rectification.

The circuit shown in Fig. 32 may be referred to. In this circuit there is resistance inserted in the plate circuit of the first

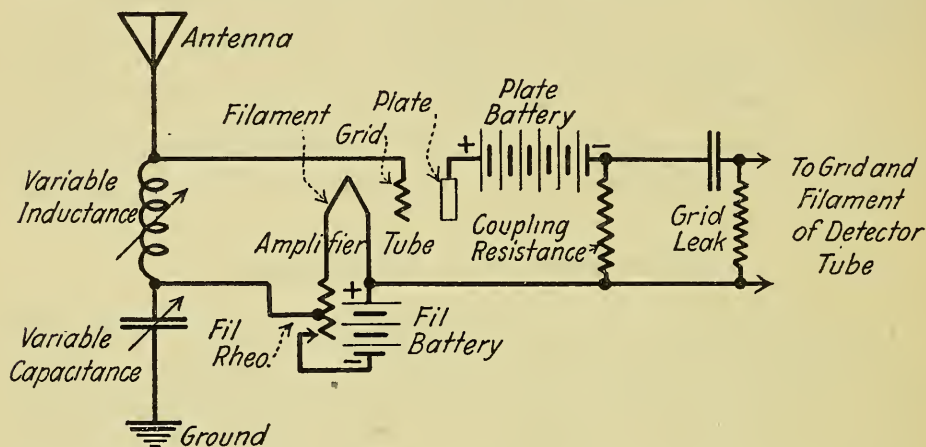

Fig. 32—Single stage of radio-frequency amplification using a coupling resistance.

or radio-frequency amplifier tube. Due to inherent amplification, the plate current variations in this first tube are greater in amplitude than the antenna oscillations. If the coupling resistance is quite large, amplified potential variations are applied to the second or detector tube. Let it be assumed that these amplified potentials are sufficient to operate the detector tube to good advantage. The rectified plate current variations will then be of audio-frequency and the telephone receiver will function providing the antenna oscillations of radio frequency are modified at an audio-frequency rate.

If one stage of radio-frequency amplification is not enough,

more amplifier tubes may be coupled together in the same manner until sufficient potential is produced to properly operate the detector tube. This is again called "cascade" amplification, but this time the amplification is of radio-frequency only. There are as many "stages" of amplification, of course, as there are amplifier tubes.

Radio-Frequency Regenerative Amplification

Referring to Fig. 33, there is a coil (air core) connected into the plate circuit of a detector tube and so placed, in relation

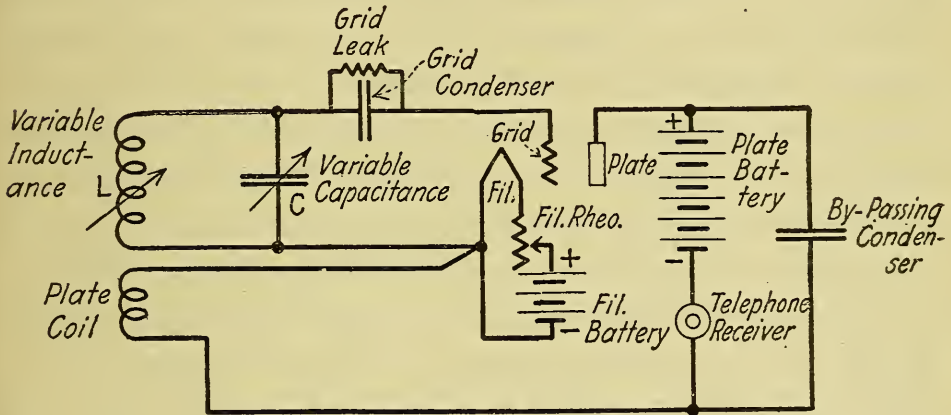

Fig. 33—Showing how energy may be fed back from the plate circuit to the grid circuit to produce regeneration.

to the grid coil, that a radio-frequency oscillating current in the plate circuit will induce a radio-frequency E.M.F. in the circuit composed of the grid coil and the condenser connected across it. The grid coil is marked "L" and the variable condenser connected across it is marked "C." The antenna circuit is not indicated, but let us assume that oscillations in the antenna circuit, in some manner, create radio-frequency potential variations at the grid coil terminals. If the circuit "LC" is tuned to resonance with the antenna oscillations, there will be oscillating current of the same frequency (radio-frequency)

in this "closed" oscillatory circuit. The oscillations in this circuit cause radio-frequency variations of potential at the terminals of the condenser "C," which are applied to the grid of the tube. Corresponding variations of plate current are therefore produced, which flow through the "by-passing condenser" (connected across the telephone receiver and the plate battery) and also through the plate coil. Being of radio-frequency, these plate current variations cannot, naturally, flow very readily through the telephone receiver. The radio-frequency variations of plate current are, of course, in step with the oscillations in the circuit "LC" and, therefore, the oscillating E.M.F. induced in that circuit by the plate coil is also in step, providing the coils are connected in the proper manner. Some of the energy of the plate circuit oscillations is transferred or "fed back" to the circuit "LC." These oscillations in "LC" are then reinforced and the potential variations across the condenser "C" are also reinforced. This in turn reinforces the potential variations on the grid and therefore the plate circuit oscillations. In this manner grid potential variations of radio frequency are increased sufficiently in amplitude until, even with a very weak signal, the detector tube will be operated to good advantage. The rectifying or detecting action of the tube goes on at the same time so that if the radio-frequency antenna oscillations are in audio-frequency groups, the telephone will respond to the audio-frequency variations of plate current and the signal is greatly amplified as well as rectified. In accordance with the characteristic action of the grid condenser, this condenser is charged in the usual manner, but its charge at the end of a group of oscillations is proportional to the resultant reinforced amplitude of grid potential variations rather than to the amplitude of radio-frequency oscillations.

This reinforcement of grid potential variations is called

“regeneration,” and the amplification produced is “regenerative amplification.” The idea is due to E. H. Armstrong, and this circuit and its many modifications are called “Armstrong circuits.”

Autodyne Production of Beats

If the distance between the plate coil and the coil “L” is decreased it is said that the “coupling” between them is increased. If this coupling is sufficiently increased a click will be heard in the telephone receiver. At this instant radio-frequency oscillations begin to be self-generated in the circuit “LC,” whose frequency will depend upon the inductance of the coil “L” and the capacitance of the condenser “C.” An increase in either inductance or capacitance (or both) in this circuit will decrease the frequency of the oscillations. On the other hand, a decrease in either or both will increase the frequency of the oscillations.

Suppose that the frequency of the antenna oscillations is 100,000 cycles and that of the self-generated oscillations is 101,000 cycles. Currents of both frequencies flow in the circuit “LC,” although the amplitude of the 100,000 cycle oscillations will not be as great as though this circuit were in resonance with the antenna circuit. Both oscillations, antenna and self-generated, are undamped (unmodified). A third oscillating current is produced in the circuit “LC” whose frequency is 1000 cycles, the numerical difference between the other two. This is the previously discussed heterodyne action except that, in this case, the local oscillations are generated by the detector tube itself. The beat frequency, in the usual manner, produces 1000 variations of plate current through the telephone receiver each second and, this being an audio-frequency, an audible response is heard in the receiver. By varying the frequency of the locally generated oscillations, the beat frequency and, there-

fore, the tone of sound in the receiver can be varied at will. Undamped ether waves thus produce undamped antenna oscillations, which are modified and rectified by the detector to produce audible signals.

This method of receiving undamped wave signals is called the "autodyne" method to distinguish it from the method in which local oscillations are generated by an entirely separate device. It is, of course, a "self-heterodyne" method, whereas that previously considered was a "separate-heterodyne" method.

If the signals are damped waves or undamped waves modulated at any audible frequency, the tone produced in the telephone receiver will be greatly distorted due to the interaction of the various frequencies, both radio and audio. In the case of speech or music reception the result is hopelessly unsatisfactory unless the frequency of the local oscillations is *exactly* the same as the antenna oscillations. In this case the speech or music will come through without much distortion, usually, and the amplification will be greatly increased. This is called "zero-beat" reception. No beat frequency is produced. When the signals are from a spark telegraph transmitter or modulated continuous wave telegraph transmitter, the natural group frequency of the oscillations will be reproduced and greatly amplified by the zero-beat method.

It is to be noted that the circuit may be exactly the same as that used for regeneration. In fact, autodyne reception is simply regeneration carried to the point where the grid potential variations are maintained at constant amplitude whether signals are being received or not.

If the coupling between the plate and grid coils is decreased to a certain point, the local oscillations will no longer be generated. Undamped (or continuous) wave signals will then no longer be heard, although radio-telephone signals, spark sig-

nals and modulated continuous wave telegraph signals may still be heard.

It is interesting to note that in the case of "beat reception" of continuous wave signals, there are two values of frequency of local oscillations which may be used to produce a beat frequency of, say, 1000 cycles. The numerical difference between 100,000 cycles, the frequency of the signal oscillations, and 9900 cycles, the frequency of local oscillations, is also 1000 cycles and an audible beat frequency. The local circuit "LC" of Fig. 32 might be adjusted so that either local frequency is produced and with a signal frequency of 100,000 cycles (wavelength of 3000 meters) the audible beat frequency and, therefore, the musical tone in the telephone receiver is the same, 1000 cycles.

There are various modifications of the regenerative and self-heterodyne circuit shown in Fig. 33, but these will be considered in detail under "Practical Circuits and Their Operation."

CHAPTER V

PRACTICAL CIRCUITS AND THEIR OPERATION

Methods of coupling—The variometer—Inter electrode tube capacitance—Wave length, Frequency and Resonance—Circuits and Explanations of their arrangement and operation.

Methods of Coupling

Two circuits, each containing inductance and capacitance, may be coupled together in any one of the ways shown in Fig. 34. If oscillations are present in one of the circuits, oscillations of the same frequency will be forced to flow in the other which is coupled to it. The first circuit is called the “primary”

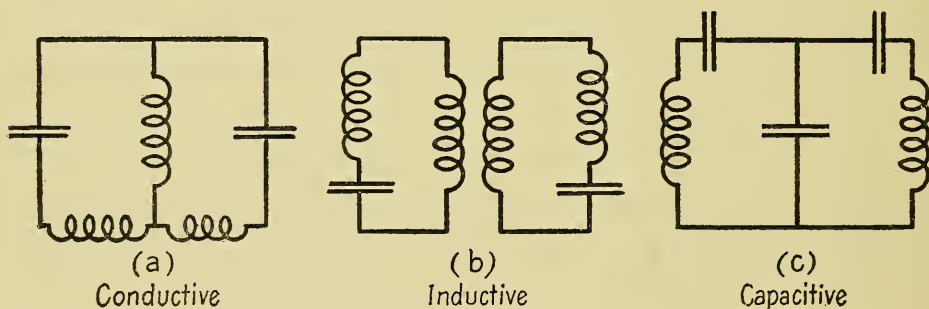

Fig. 34—Methods of coupling.

and the second is called the “secondary” circuit. The oscillations which are forced to flow in a secondary circuit are called “forced oscillations.” Their amplitudes will not be maximum unless the secondary circuit is tuned to resonance with the primary. This is true no matter what kind of coupling is considered.

In Fig. 34 (a) the primary and secondary circuits are coupled through the inductance which is common to both

circuits and the coupling is called "conductive." In Fig. 34 (b) there is what is known as "mutual inductance" between the two coupling coils. In few words, there is an inductive (inducing) effect of each coil upon the other, although the coils are not necessarily physically or electrically connected with each other. This is called "inductive" coupling. Fig. 34 (c) shows a capacitance to be common to both primary and secondary circuits. The coupling between the two is made through this capacitance and is, therefore, called "capacitive" coupling.

The primary circuit may in any of the above cases be considered to be an antenna circuit, since it contains both inductance and capacitance.

The Variometer

A continuously variable inductance is quite often required for the close adjustments frequently necessary in vacuum tube circuits. If a coil of wire is tapped at every turn so that the inductance may be varied turn by turn the variation might not be smooth enough. That is, it might be necessary to secure a variation of inductance less than that of one turn on the coil. In this case a variometer may be used whose construction may be quite similar to that shown in Fig. 35. The coil which may be turned is called the "rotor" and the stationary coil is called the "stator." The inductance of a variometer may be varied by varying the coupling between the rotor and the stator which are connected together.

Inter-Electrode Tube Capacitance

The filament, grid and plate of a vacuum tube all have some surface area and, in operation, have electric charges placed

upon them. It is not hard to imagine them as being plates of small condensers with the vacuum space between them acting as a dielectric. There is thus capacitance between the tube electrodes which may have certain effects upon the circuits of the grid and plate. There is a condenser effect between

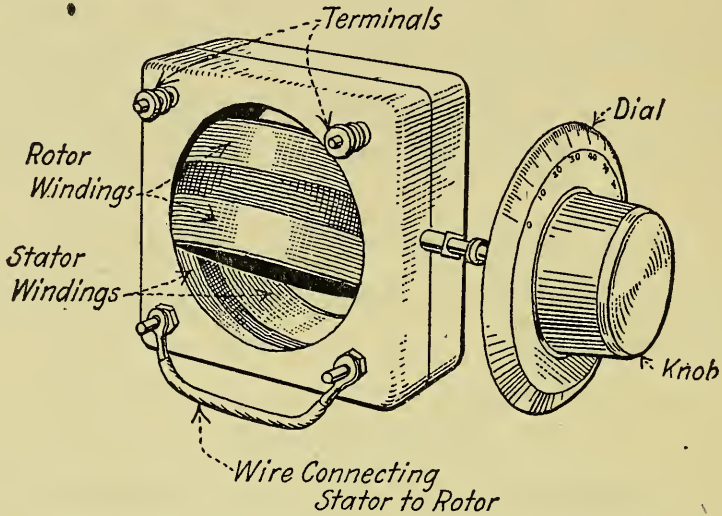

Fig. 35—Construction of a typical variometer.

the grid and the plate and another between the grid and the filament. In some cases the condenser effect may be considered, as shown in Fig. 36, where a certain amount of capacitance is common to both the grid and plate circuits. The circuits are then considered as being coupled together by “capacitive” coupling.

Wave Length, Frequency and Resonance

It will be recalled that as the frequency of ether oscillations decreases, the wave length of the oscillations increases and vice versa. When a circuit is in resonance with another at a certain frequency it may also be said that they are in resonance at a certain wave length corresponding to that particular

frequency. If the frequency is 1,000,000 cycles per second, the wave length is 300 meters (300,000,000 meters per second, being the velocity). The relation of frequency to wave length is thus clearly shown. From now on we shall also think in terms of wave length.

Now, it may be recalled that the frequency, and we may say also the wave length, at which any given circuit is in

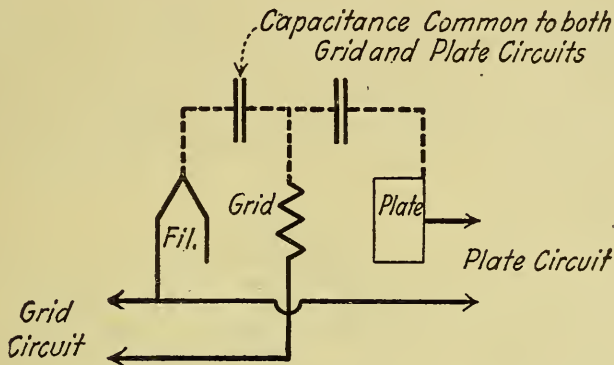

Fig. 36—Inter-electrode tube capacitance.

resonance with another depends upon the capacitance and inductance of the circuit. Either a comparatively large inductance and a small capacitance or a small inductance and a large capacitance may be used and, providing the values of each are correct in each case, the circuit will be in resonance. There may be a preponderance of inductance or a preponderance of capacitance. It is neutralization of the two opposite reactances which places a circuit in resonance with another at a particular frequency or wave length. Let us consider a case in point. Suppose that with an inductance of 10 units value and a capacitance of 5 units value the circuit is in resonance at the wave length of 300 meters. The circuit will also be in resonance if the inductance is of 5 units and the capacitance of 10 units value. The product of the two is 50 in each case. Now, the product of a number of other values of inductance and capacitance may also be 50; for example,

inductance equals 50 units and capacitance equals 1 unit. So long as the product of the two equals 50, the circuit will, in this case, be resonant at the wave length of 300 meters. This is quite important and must be borne in mind in the consideration of circuit operation.

Circuits

The circuits schematically shown in the following diagrams are those which are probably in most common use and are entirely practicable. Many variations could be made in them

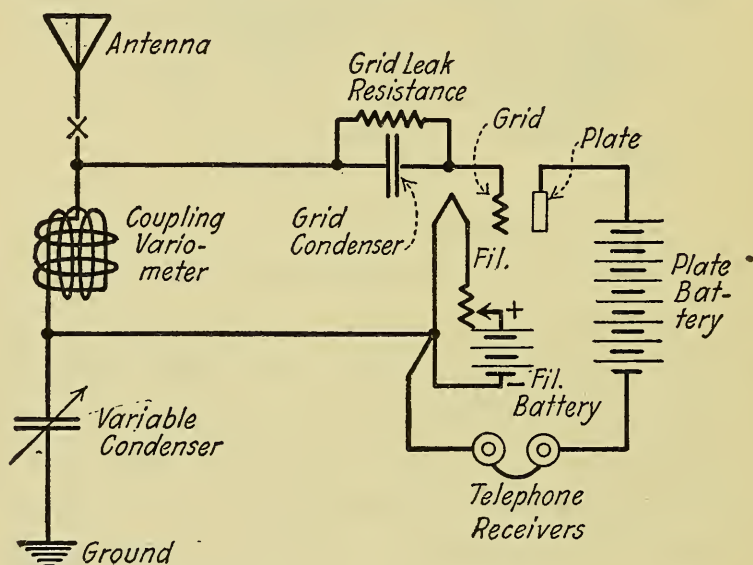

Fig. 37—Simple Single Circuit Receiver.

and there are receiving circuits almost by the hundreds which are workable but not in common use. No attempt will be made to illustrate every possible connection of vacuum tubes into detector or amplifier circuits.

Fig. 37 is a detector circuit with grid condenser in which the coupling between the antenna and grid circuit is conductive. The secondary circuit is not tuned to resonance

with the primary, although it contains both inductance and capacitance. It may be called an "untuned secondary" circuit. A receiver with such a circuit is said to be a "single circuit receiver" because only one circuit, the antenna, is tunable.

In the operation of this circuit, the antenna is tuned to resonance with the radio frequency oscillations induced in it by the transmitting station it is desired to receive from. If the plate battery voltage and filament current have been so adjusted that the normal operating point is on the straight portion of the characteristic curve, signals of maximum obtainable audibility will be heard in the pair of telephone receivers.

The circuit shows the antenna inductance to be a variometer and it will be good for the reception of short waves. To receive long waves an inductance, called a "loading inductance," may be inserted in series at point "X."

With this circuit, the ability to cut out forced antenna oscillations from a station transmitting on a different wave length will depend upon the ratio of the total antenna inductance to total antenna capacity. By increasing the inductance and simultaneously decreasing the capacitance a value of each will be found which will again put the circuit in resonance with somewhat greater freedom from interference caused by the unwanted station. This is sometimes called "stiffening" the circuit. There is a drawback to this circuit, as if the inductance of the variometer is increased, the coupling between the antenna and the grid circuit is also increased. This would counteract the value of stiffening the circuit, since increased coupling means increased liability of interference. The disadvantage could be overcome to some extent by using a loading coil. The coupling in no case, however, may be made as loose as is often desirable for the elimination of

strong interfering signals and atmospherics. Such a circuit is used for the reception of damped waves only (spark, voice, etc).

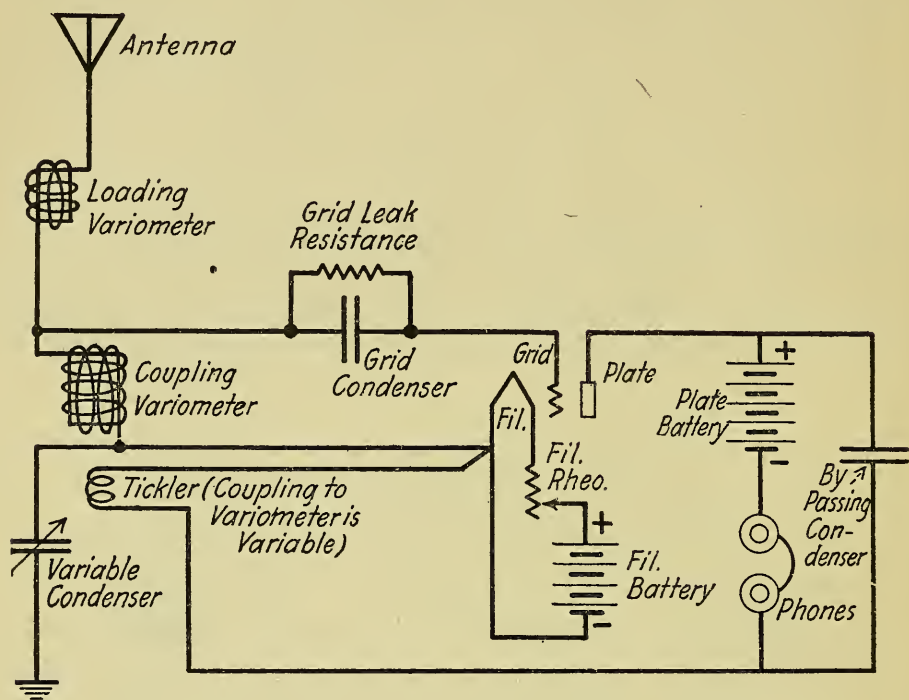

Fig. 38—Single Circuit Regenerative Receiver.

Fig. 38 is practically the same as Fig. 37, with the exception that a plate coil is inductively coupled to the antenna variometer. The coupling between the variometer and plate coil is variable, so that the degree of grid potential reinforcement may be controlled. This plate coil is usually referred to as a "tickler," since it "tickles" the grid potential variations, due to antenna oscillations. If the coupling between the tickler and the variometer is sufficiently increased, oscillations whose frequency will be determined by the antenna inductance and capacitance will be self-generated to produce beats. This is the autodyne action previously discussed. If the coupling is reduced below the point where oscillations are self-generated,

there is amplification by regeneration and this receiving circuit can be made quite sensitive to weak signals.

In all other respects the circuit is quite similar to that of Fig. 37. When the autodyne action is used for the reception of unmodulated undamped waves, or "C. W." (continuous waves), the tuning is much sharper than when the regenerative effect is used for damped waves. For example, suppose the frequency of the desired signal to be 100,000 cycles (wave length 3000 meters) and forced oscillations in the antenna from an interfering station to be 200,000 cycles per second (wave length 1500 meters). The frequency of local oscillations is assumed to be 101,000 cycles. The beat frequency produced by the interaction of frequencies of 100,000 and 101,000 cycles is 1000 cycles, an audible frequency. But the beat frequency, due to oscillations of 200,000 and 101,000 cycles, is 99,000 cycles, an inaudible frequency. The signal on the 3000 meter wave would be heard but that on the 1500 meter wave would not be heard at all. Both might be heard with a single circuit receiver, however, if they were modified at an audio-frequency rate (or were damped oscillations), although the receiver might be only in resonance at the 3000 meter wave.

A receiver having such a circuit may be called a "single circuit, regenerative receiver."

The inductance and capacitance are sometimes operated by one tuning knob so that both are variable at the same time. In such a case the single circuit, regenerative tuner may be made very simple to operate and the tuning will be fairly sharp so long as the ratio of antenna inductance to capacitance is high for all wave lengths. Selectivity, or sharpness of tuning, has to be sacrificed to some extent, however, for increased simplicity of operation.

In Fig. 39 the antenna is inductively coupled to the

grid circuit of the detector tube and a condenser is connected across the secondary coil and variometer. The coupling coils may have fixed inductance and the variometers may be used for inductance variations. When the plate potential and filament current of the tube have been adjusted the antenna

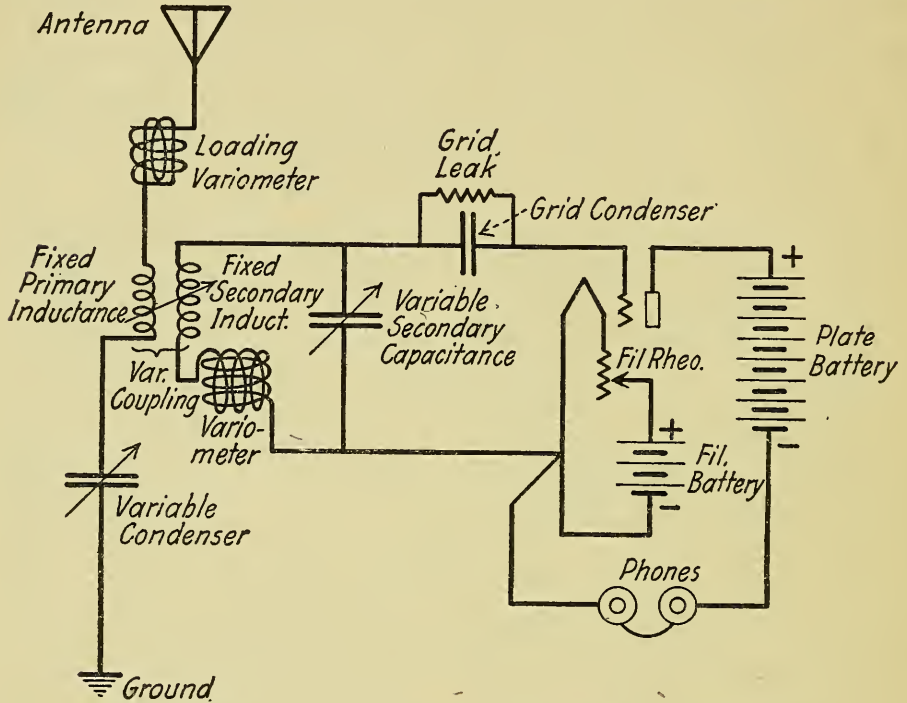

Fig. 39—Two Circuit Receiver, Inductive Coupling.

may be tuned to resonance with a signal by varying either the inductance of the variometer or the capacitance of the condenser in that circuit. Large values of inductance and small values of capacitance should be used for sharp tuning. Oscillations are then induced in the secondary circuit and their amplitudes made maximum by tuning the circuit to resonance with the antenna. The secondary variometer and condenser are used for this purpose. Large values of inductance and small values of capacitance for resonance should also be used here. A decrease of coupling decreases the amplitudes

of the secondary oscillations, but increases the sharpness of tuning. The object is, then, to use as little coupling as possible without reducing the signal too greatly. When coupling adjustments are made it will be found necessary to slightly alter the resonance adjustments of both the antenna and secondary circuits. Variations of coupling have an effect upon the inductance values.

With this circuit the sharpness of tuning may be increased very materially over that possible with any single circuit. A receiver having this sort of circuit might be called a "two-

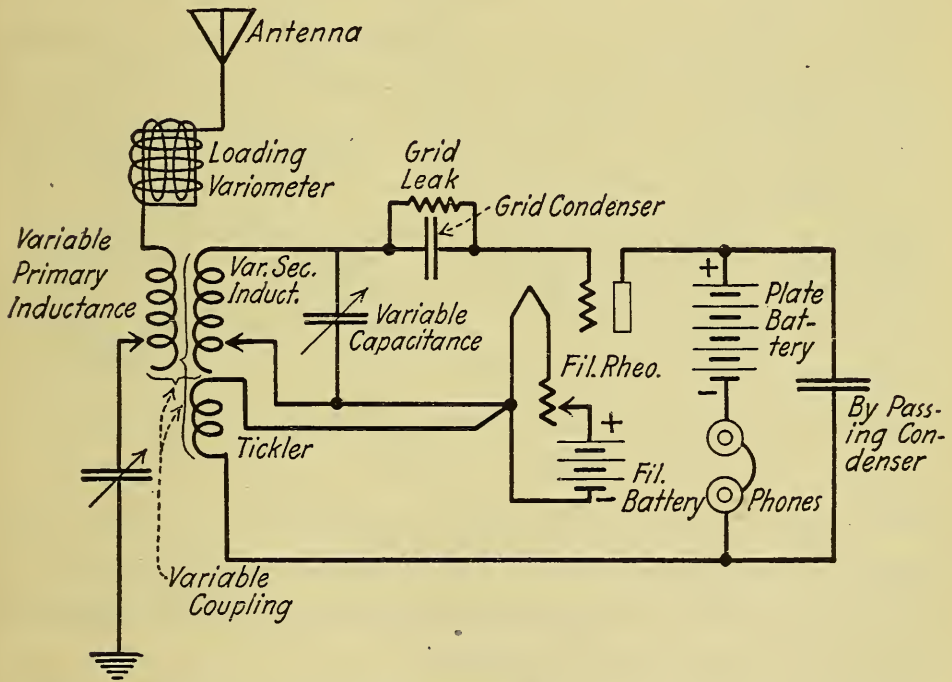

Fig. 40—Two Circuit Regenerative Receiver, Inductive Coupling.

circuit receiver," because there are two circuits to tune.

Oscillations in the secondary circuits, of course, cause oscillating potential variations to be applied to the grid of the tube, but there is no regeneration and it is possible for a signal to be too weak to operate the detector. The circuit is not adapted

to the reception of unmodified continuous waves, but may be used for damped waves (spark, radio-telephone, etc.).

Fig. 40 is almost exactly the same circuit as in Fig. 39, except that regeneration may be had by means of the tickler coupling. Here again the unmodified continuous wave signals may be received by the beat method if local oscillations of the proper frequency are generated. The frequency of the local oscillations is controlled by the adjustment of secondary inductance and capacitance. Sharpness of tuning may still be had because of beat reception in the same manner as set forth in the discussion of Fig. 38.

When regeneration is used the signals may be continuously amplified by increasing the tickler coupling up to the point where local oscillations start. Just before the oscillations start the undamped wave signals will be loudest, but after that degree of coupling is passed the locally generated oscillations will distort the tone if beats are produced. In the case of radio-telephone reception this would make speech either hard to understand or even unintelligible. Beats may be avoided, even though local oscillations are generated, by tuning the secondary to exact resonance with the antenna circuit. Reception is then accomplished by the zero-beat method. This will give maximum amplification of all damped wave signals, but in the case of voice or music there may be some slight distortion, due to the varying tone frequency.

In the reception of straight undamped waves there are, of course, locally generated frequencies both above and below the signal frequency which will give beat reception. The following is an interesting experiment. Adjust the tickler coupling until local oscillations are fairly strong. Then, starting with a secondary circuit adjustment such that the frequency of generated oscillations is somewhat above that of

the signal oscillations, increase the secondary capacitance gradually. This decreases the frequency of the local oscillations and the beat tone until finally no sound is heard. Then keep on increasing the capacitance to still further decrease the frequency of the local oscillations *below* that of the signal oscillations. This increases the difference between the two frequencies and the beat tone increases. When no signal was heard the beat frequency was, of course, zero (zero-beat).

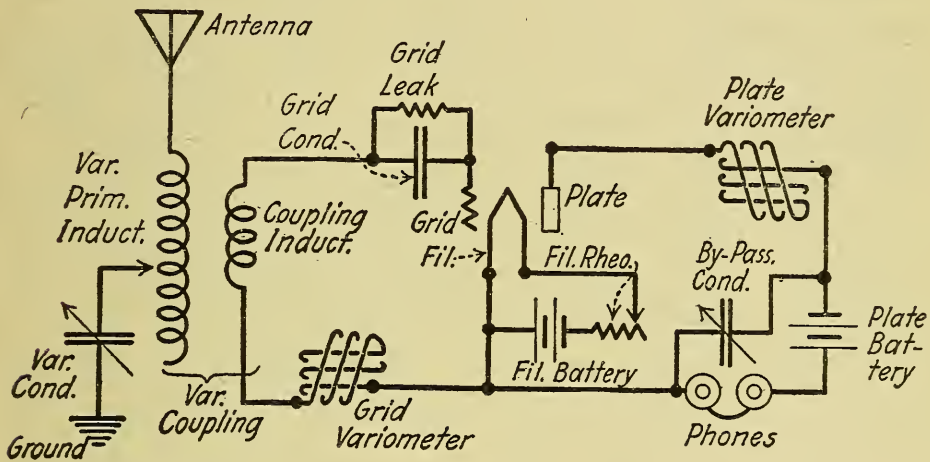

Fig. 41—Three Circuit Regenerative Receiver for Short Waves.

In Fig. 41 the antenna, grid and the plate circuit may be tuned—three circuits. The third, or plate, circuit may be called the “tertiary” circuit. Both the grid and plate circuits contain a certain amount of capacitance, due to the capacitance within the tube. The tube capacitance in this kind of circuit is the main means of feeding back energy from the plate to the grid circuit. Either circuit may be tuned by varying the inductance of a variometer. There are two variometers, the “grid variometer” and the “plate variometer,” shown in the figure.

The circuit illustrated is better for the very short waves

than it is for the longer because of the small inter-electrode capacitance of the tube.

In the reception of damped wave signals (spark, voice, etc.) the antenna is tuned to the signal wave and the grid circuit tuned to the antenna in the usual manner. As the plate variometer inductance is increased from a minimum value the oscillating grid potentials become more and more greatly reinforced until a certain inductance value is reached which puts the plate circuit in resonance with the grid circuit. The rectifying action goes on at the same time as does the amplification due to regeneration. The result in the telephone receivers is then maximum when all three circuits are in resonance.

An autodyne action may also be secured for the production of a beat frequency when the reception of continuous waves is desired. Local oscillations may be generated in the tube circuits, providing the capacitive coupling between plate and grid circuits is large enough. The frequency of the self-generated oscillations, in the circuit under consideration, will not depend very closely upon the inductance and capacitance of the grid circuit because the plate circuit will exert a somewhat greater influence. By adjusting both the grid and plate variometers, however, a local oscillation frequency will be secured which will produce the desired beat tone in the telephone receivers. One circuit has a tendency to pull the other into step with it in a manner quite similar to that of the synchronization of two alternating current generators at a power station.

Fig. 42 is quite similar to that of the preceding circuit with the exception of a variable capacitance used to couple the grid and plate circuits. This capacitance may be used to increase the tube capacitance and therefore the coupling between the tube circuits. By increasing this capacitance

(switch closed) the operation becomes more effective at the longer waves (lower frequencies).

In all other respects this circuit is practically the same in operation as the preceding one.

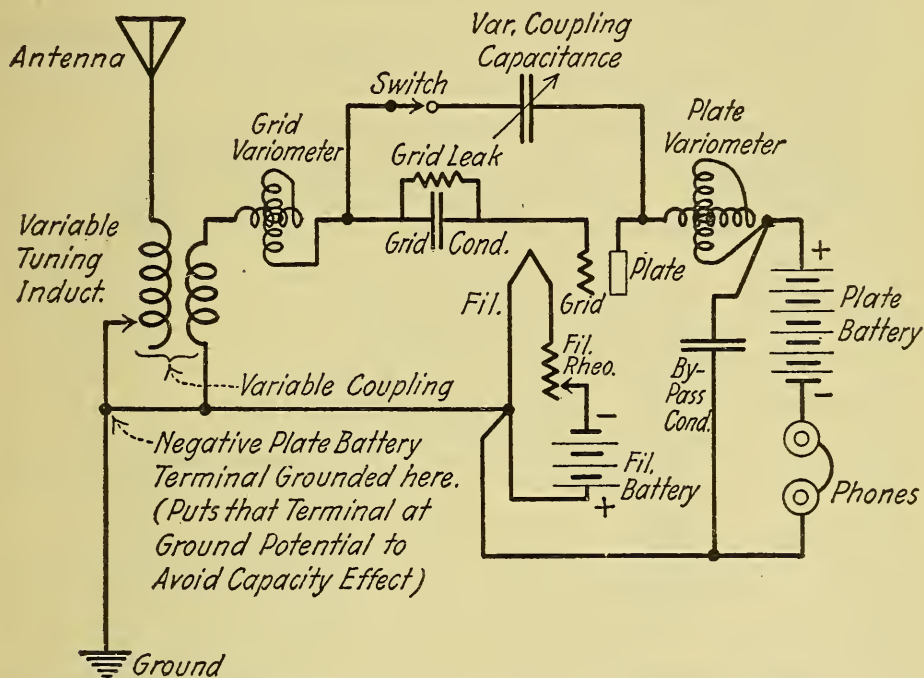

Fig. 42—Three Circuit Regenerative Receiver for Short and Medium Waves.

In Fig. 43 is shown the schematic circuit of a two stage audio-frequency amplifier coupled to a detector. If in any of the previous circuits the grid circuit of the first amplifier tube is connected into the plate circuit of the detector tube (through the transformer) in place of the telephone receivers, the detector energy at audio-frequency may be amplified. The connections are only shown for one type of detector circuit. The operating point must be adjusted to the straight portion of the characteristic curve in the case of each of the amplifier tubes in order to avoid distortion effects. This is done by applying a normal negative potential to the grids in the manner

shown and by adjusting the plate battery voltage and filament current to the proper values. It is customary to burn the filament at a constant voltage rather than at a constant current, since this increases the life of the filament. It may then be

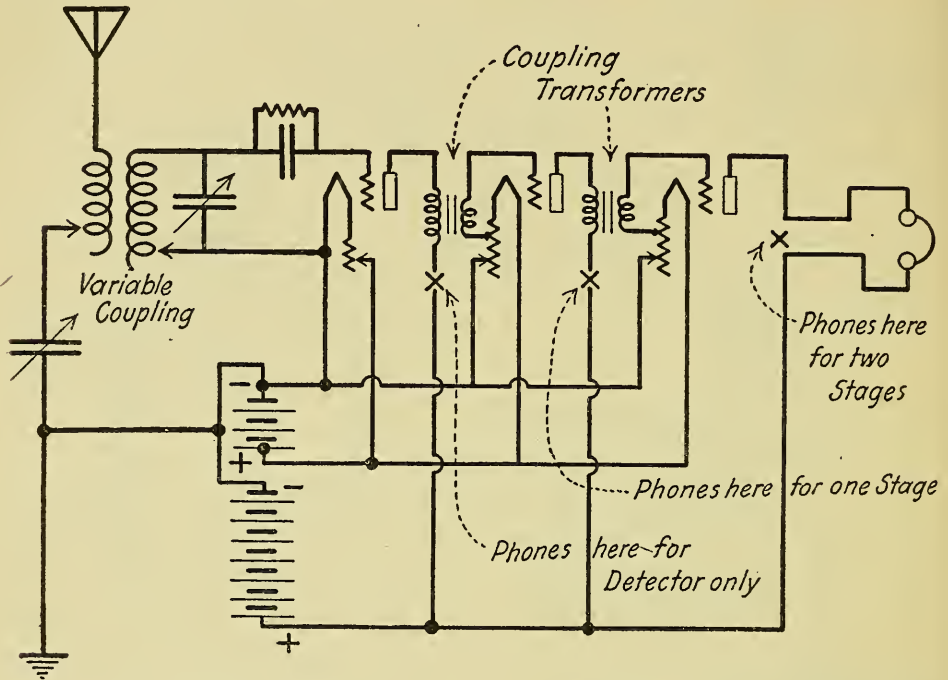

Fig. 43—Two Circuit Receiver with Two-Stage Audio-frequency Amplifier. No Regeneration.

necessary to vary the plate battery voltage from time to time as the filament ages.

The coupling transformers have closed iron cores like the illustration of Fig. 44.

The upper Fig. 45 shows a two stage resistance coupled radio-frequency amplifier connected to a detector circuit. The antenna and secondary circuits are tuned to the signal wave and the oscillating potentials applied to the grid circuit of the first amplifier tube are of radio-frequency. The oscillating potentials applied to the grid circuit of the detector tube are thereby amplified and result in greatly amplified plate current

variations in this detector circuit. If care is taken to operate the amplifier tubes with the operating points on the straight portion of their characteristic curves, distortion can usually be avoided.

The resistance coupled radio-frequency amplifiers are somewhat more suited to the longer wave lengths (lower radio-frequencies) and one of their big disadvantages is that a high

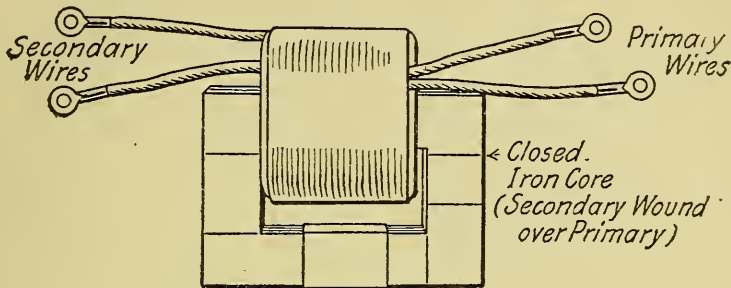

Fig. 44—Typical audio-frequency coupling transformer.

plate battery voltage is necessary to pass sufficiently large plate currents through the coupling resistances. For this reason it is common practice to use specially designed radio-frequency transformers (lower figure) in place of the resistances. The transformers are usually better at the lower frequencies (longer waves), but the chances appear to be good to use them even with the very short waves. One big advantage they have is that a large plate battery voltage is not required.

In the case of transformers, the iron core must be very carefully constructed so that too much loss of energy will not take place in the core itself. Usually it is difficult to eliminate the core losses to any very great extent when operation is with high frequency currents. The subject of design, however, is beyond the scope of this little book.

In Fig. 46 the schematic connections of a three stage radio-

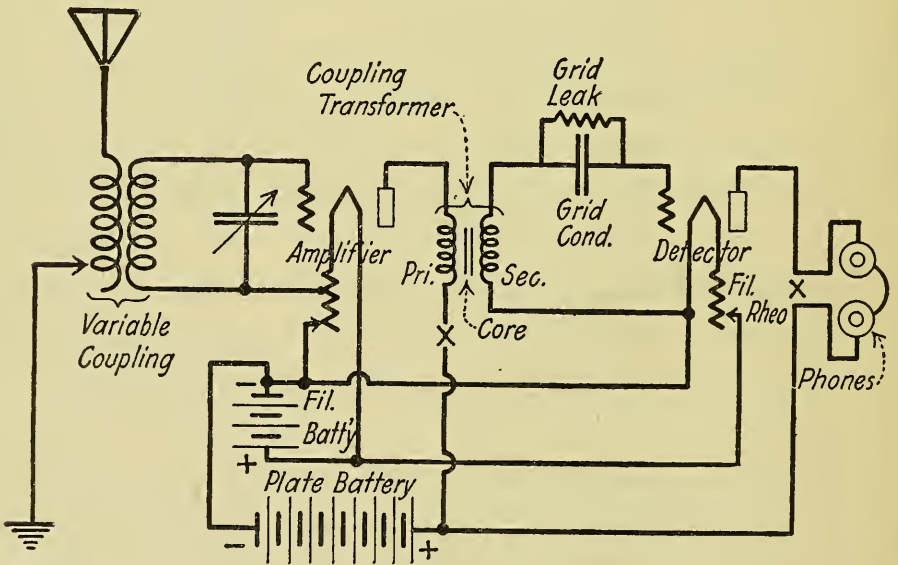
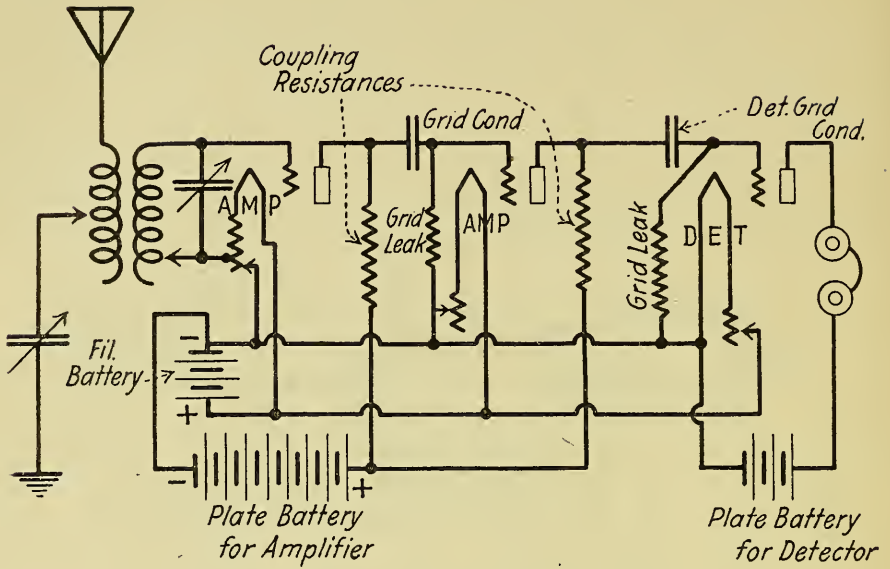

Fig. 45—Two circuits for radio-frequency amplification and detection. Two Circuit Receivers in Each Circuit.

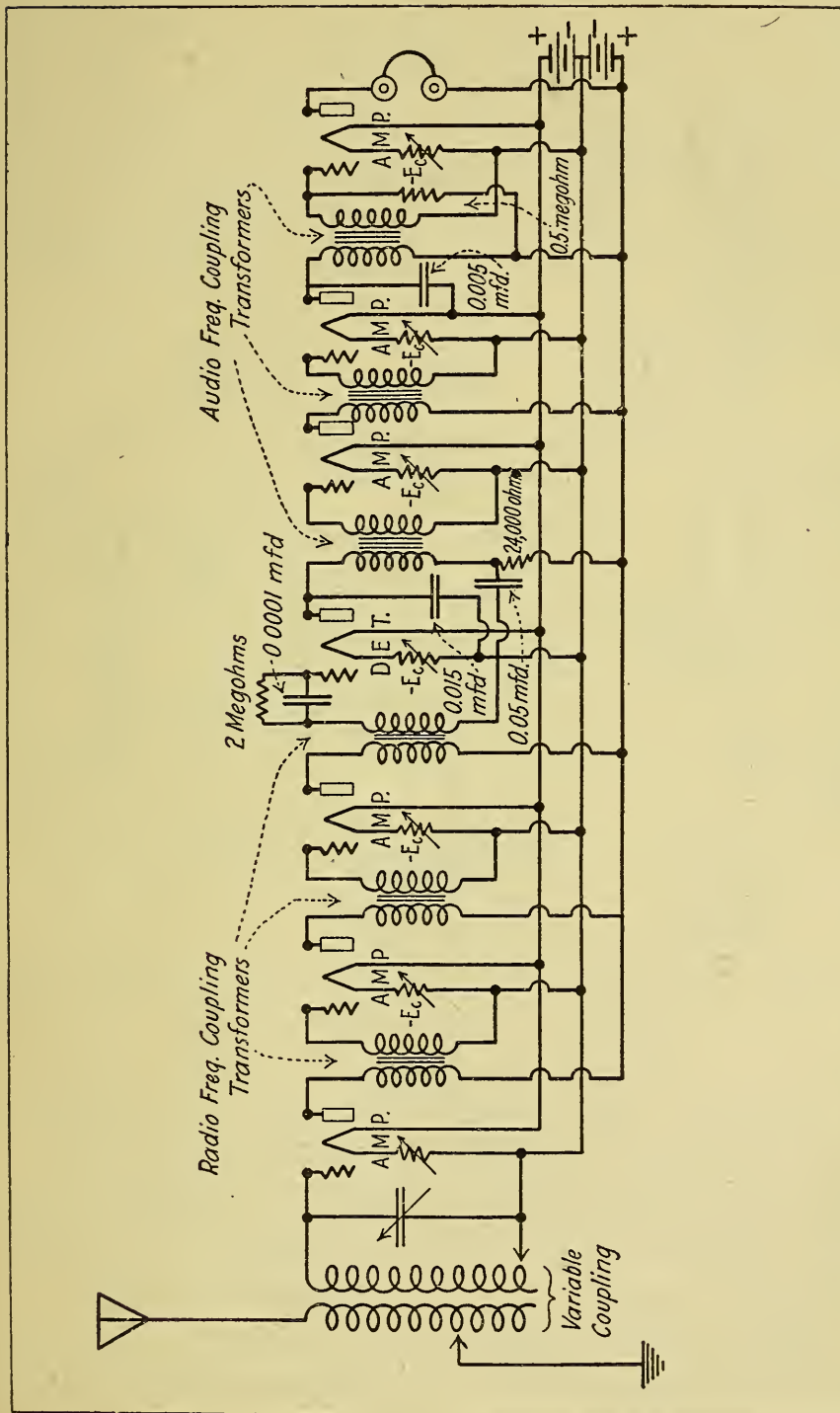

Fig. 46—Radio Frequency Amplifier, Detector and Audio-frequency Amplifier connected to Two Circuit Receiver.

frequency amplifier, detector and three stage audio-frequency amplifier are shown. If distortion is to be avoided in such a circuit (or circuits) great care must be taken to have the proper potentials applied to the grids of the amplifier tubes. Enormous amplification can be secured, however, and enough current variation produced in the plate circuit of the last audio-frequency stage to operate a relay or a "loud-speaker"

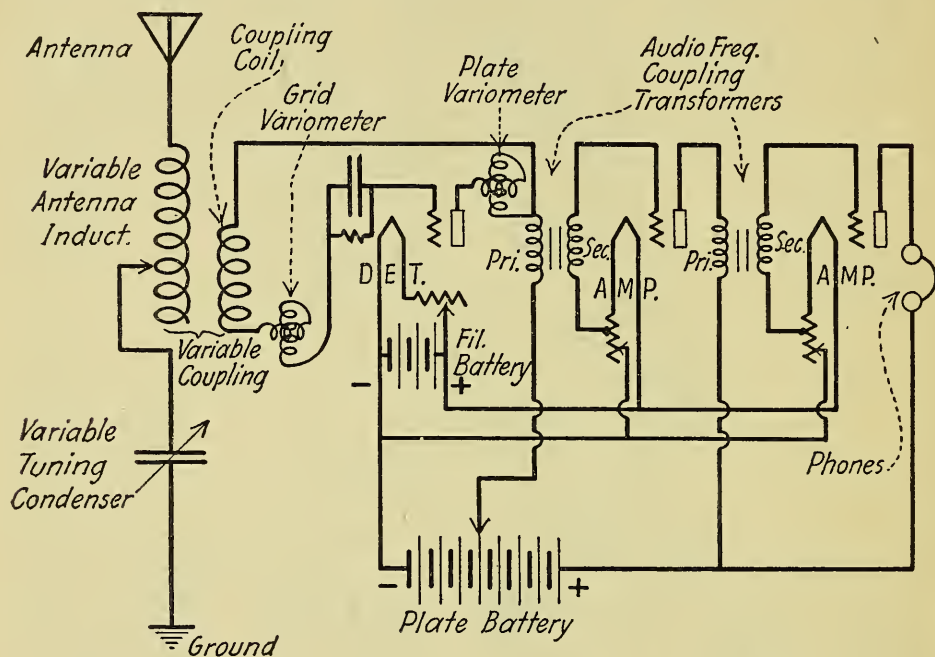

Fig. 47—Suggestion for Short Wave Regenerative Receiver and Two Stage Audio-frequency Amplifier.

on an extremely weak signal which could not possibly be heard with a detector and audio-frequency amplifier alone.

Distortion *can* be avoided even in such a complicated amplifier with many stages, and distortion of speech will be taken up in the next chapter.

The circuit of Fig. 47 eliminates the necessity of a by-pass condenser in the plate circuit. In the usual circuit this by-pass condenser is required to permit the plate circuit oscillations,

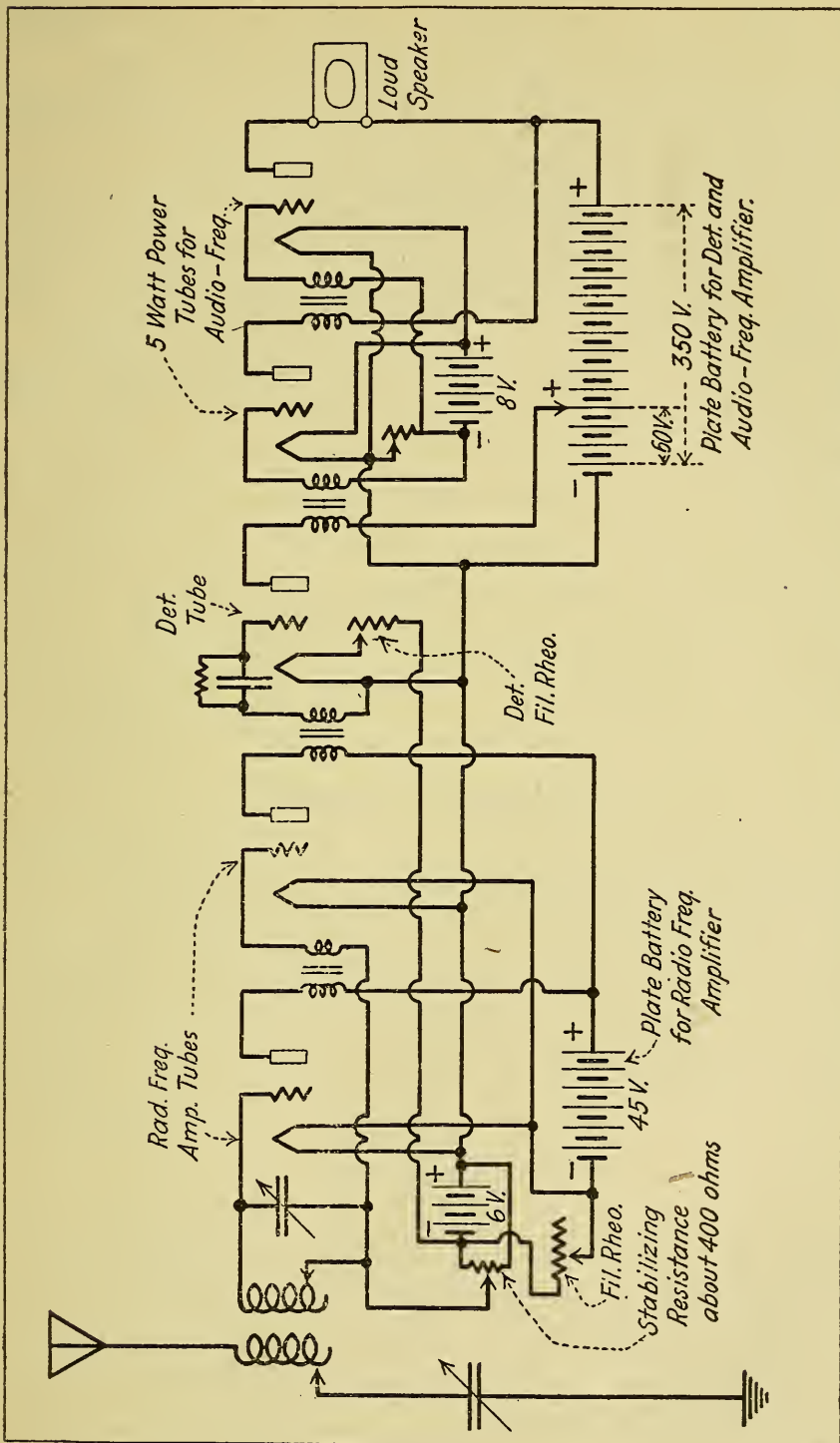

Fig. 48—Suggestion for the reception of weak signals.

since, without it, the inductive reactance of the telephone receivers would be too great to pass these oscillations.

The circuit is very effective and operates in a manner almost identical with that of previous tuned plate circuits.

It may be said, in this connection, that all circuits in which the plate is also tunable are called "tertiary tuned circuits" and that receivers so designed are called "three circuit receivers."

The circuit is shown connected to a two stage audio-frequency amplifier.

CHAPTER VI

Voice Distortion

Amplifier transformers—Normal grid potential—Too great regeneration—Telephone receiver.

If speech and music are received from a given station without distortion on a crystal detector and distortion is encountered when the crystal is replaced by vacuum tube circuits, it may be easily assumed that the distortion is caused in the receiving circuits. It may, therefore, be of interest to consider some of the causes of voice distortion in a receiver and amplifier.

Amplifier Transformers

Distortion is often due to a poorly designed coupling transformer in the case of either audio or radio-frequency cascade amplification. The distortion will in this case be produced regardless of the degree of care taken to prevent it in other directions. The remedy is, of course, a properly designed transformer.

Grid Potential

It has already been pointed out that in the case of either audio or radio-frequency cascade amplification it is quite necessary to have the operating point of each amplifier tube on the straight portion of the characteristic curve. Moreover, it should be as nearly as possible at the middle of the straight portion, so that neither a large positive or a large negative value of applied

grid potential (due to the signal) will swing the resultant grid potential down to the "cut-off" value or up to the value where plate saturation takes place. In order to accomplish these desired results in practice, it is desirable to have a sufficiently large plate battery voltage (normal plate potential) and a sufficiently large normal negative potential on the grid. The desired grid potential is preferably secured by including a sufficient amount of the filament rheostat resistance in the grid circuit. The manner of accomplishing this has been previously pointed out.

In some cases, however, the input (applied) grid potential variations may be too great in amplitude, even though the above precautions are taken. This is a result, usually, of too much regeneration, even though local oscillations may not be, at the same time, produced. With a regenerative receiver it quite frequently happens that operation will be without distortion until a loud tone causes the grid potential to shoot up and a loud blaring noise to be heard. In this case, sacrifice some audibility by reducing the tickler coupling (or readjusting the plate variometer) and with it the degree of regeneration. More nearly distortionless reception will result. This kind of distortion (due to too great input voltage) may also be caused by using too many stages of amplification with too little plate voltage in the circuits of the last amplifier tubes. Increase of plate voltage will frequently correct the trouble, but if not, then a small power amplifier tube may be used and large plate voltage applied to it. This is one reason why more than two or three stages of audio-frequency cascade amplification are inadvisable.

If the signal is very weak, serious distortion may be caused by a flow of grid current when the resultant grid potential periodically reaches a positive value. This would cause actual rectification in the grid circuit and, therefore, distortion of

the plate current variations. The remedy is to apply the proper value of normal negative grid potential.

When an amplifier cabinet has been properly designed, provision has been made for the proper normal negative grid potential when the filament current is of normal value. In the operation of such a cabinet amplifier it is then only necessary to secure the proper amount of filament current (adjustable at the rheostat) and the proper value of plate battery voltage.

Too Great Regeneration

In any kind of a regenerative circuit receiver, too much regeneration will, as has been pointed out, cause distortion of the loud tones. To avoid this distortion care must be taken that the operation is below the point where oscillations start. Regeneration in any degree also has a tendency to either subdue or slightly distort the delicate overtones and harmonics of sound. Better reproduction of voice and music is secured when no regeneration is used, but the tendency is to use it to increase the volume of sound. A better way would be to use a tuned secondary circuit with a straight detector (no feed-back) and to bring up the volume by cascade audio-frequency amplification in as few stages as possible. The number of stages necessary is reduced when power (or transmitting) tubes are used with large plate voltages.

Overloading of Tubes

It was stated above that by increasing plate battery voltage certain causes of distortion might be overcome. If the voltage is higher, however, than that at which the tube is rated, distortion may be caused by overloading. The rule then would

be to use the power tubes, which will permit of the large plate voltages without overloading. It is understood that the use of power tubes for amplification means extra expense for both the tubes and the plate batteries, but the result is usually worth the investment.

Telephone Receiver

Some telephone receivers are inherently prone to cause distortion, but this is a matter of selection of equipment. Also, if the audio-frequency plate current variations are of too great amplitudes the receiver diaphragms may rattle. The rattling is often directly due to such strong vibrations that the diaphragm hits the magnet poles. Sometimes, but not always, this rattling may be stopped by screwing the receiver cap on tighter to prevent the diaphragm from "jumping." Another cause of distortion in a telephone receiver is the resonance had at times between the natural period of vibration of the diaphragm and the tone frequency. This is again, however, a matter of selecting a pair of receivers to avoid the effect. Some "loud speakers" are made of a telephone receiver connected with a horn. In such cases resonance effects may be had in the diaphragm or in the horn itself if it is of metal. The design of an ideal loud speaker is still a goal to be attained, although some types approach the ideal quite closely.

Conclusion

Absolute absence of all distortion is almost impossible, since mechanical and electrical devices cannot be made absolutely perfect reproducers of the human voice. Perfection may be, and is, however, closely approximated when care is taken in

the design *and* operation of apparatus. This must not be taken to mean that very fine practical results in voice reproduction are only accomplished with great difficulty. Very fine results may indeed be obtained with present equipment if the comparatively few precautions are observed in operation. There probably will always be room for some improvement, however, as is the case with most things.

CHAPTER VII

PRACTICAL QUESTIONS AND ANSWERS

1. Can insulated wires be used in an antenna (or aerial)?

Ans. Yes, since the ether waves pass through insulating materials very readily.

2. How many wires are necessary in a receiving antenna?

Ans. Only one wire is necessary and there is no practical advantage in using more than one.

3. What kind of wire should be used?

Ans. Any kind of copper, aluminum, phosphor bronze or silicon bronze wire may be used. Even iron wire may be used in some cases, although it is not recommended. The wire used should have sufficient tensile strength to stand the strains imposed upon it by the weight of a span and the wind pressure against it. It should be of low resistance to high frequency alternating current. Since the radio-frequency oscillations in an antenna travel mostly upon the surface of the conductor, a copper clad wire may be used. A stranded phosphor bronze or silicon bronze wire has good tensile strength and is a very good conductor of high frequency current.

4. Is it absolutely necessary to insulate an antenna?

Ans. In dry weather an uninsulated antenna may be used without much leakage. In damp weather, however, it is quite necessary to have the antenna insulated at all points of support. Ordinary porcelain insulators are suitable.

5. Is it necessary to have the antenna as far as possible from metallic objects and structures?

Ans. It is always best to keep the antenna as far away from metallic structures as possible. It is not absolutely necessary to have it any great distance away, but, in general, the further away the better the results.

6. Is it necessary to solder the joints in a receiving antenna?

Ans. It is highly advisable to do so, particularly if the antenna is to be more or less permanent. The corrosion of the wire at the joints will increase the resistance at those points unless the joints are soldered. A non-corrosive flux should be used in soldering. At best, the oscillating current flowing in a receiving antenna circuit is of small value, and it is very necessary not to allow the antenna resistance to be any greater than can be helped. The lower the resistance the stronger the current which will flow in the antenna, all other things being equal.

7. Where should the lead-in from the antenna be connected to it?

Ans. It should be connected to that end of the antenna which is nearest the station it is particularly desired to receive from. If this cannot be done the lead-in may be connected to the middle of the antenna, providing the horizontal part is long enough. In the former case there would be an inverted "L" and in the latter a "T" type antenna thereby secured. The wave length is somewhat decreased when the lead is taken from the middle of any given horizontal portion. If it is not practicable to erect an antenna with a horizontal portion, a nearly perpendicular wire may be suspended from a high object.

8. How long should the antenna be?

Ans. This depends upon the wave lengths to be received. The horizontal portion may be about 100 feet long for the short waves, 200 feet long for moderate length waves

and 300 feet for the long waves. The antenna should not be over about fifty or sixty feet high from the ground or from the top of a building with the above lengths. If the height is reduced the wire may be made somewhat longer. A total length of wire (horizontal part plus lead-in) may well be about 150 or 160 feet for short wave reception.

9. How high should the antenna be?

Ans. This is partially answered in the above. In general, the higher the better. The height of an antenna erected upon a roof should be reckoned from the roof upwards, unless only a comparatively small portion of the antenna is directly above the roof. If the antenna is in an open space with no buildings or only small sheds beneath it, the height may be reckoned from the ground, providing the receiving apparatus is at or near the ground level.

10. Can a gas pipe, fire escape, drain pipe, and so forth, be used for an antenna?

Ans. In some cases any one of them might be used, providing efficient receiving apparatus is used at the same time. A gas pipe has been known to equal a rather poor antenna for receiving, but vacuum tubes and not a crystal detector were used. Bed springs may be sometimes used for antenna, providing the transmitting station is not too far away. The regular antenna gives better results usually in all cases.

11. How shall the ground be arranged?

Ans. A counterpoise ground composed of wires insulated from the earth and radiating from the receiving station at a height of about ten feet from the earth makes a very fine ground because of its comparatively low resistance. This is not possible in many cases, and even when possible the results sometimes do not justify the trouble and expense. This kind of a "ground" is highly desirable for transmitting, however.

The next best arrangement is connection to the cold water pipe. The connection should be well made. If this is not possible the ground wire may be connected to a radiator pipe and very good results are often had.

12. May a loop antenna be used to good advantage?

Ans. A loop may be used to very good advantage, providing it is of the proper dimensions for the wave lengths to be received, and providing the proper receiving equipment is used with it. Usually it is necessary to use radio-frequency cascade amplification if the transmitting station is some distance away. The loop antenna may be used to eliminate much of the interference encountered with a regular antenna and the loop should be arranged to rotate so that its position may be set for reception from a particular station. The loop is very directional.

13. May a loading coil be used to increase the wave length of the antenna?

Ans. Yes, a loading coil may be used, and if the amount of inductance required is not too great a variometer makes a very fine loading coil. If the antenna is "loaded" it is usually also necessary to load the secondary circuit of the tuner, if it is of the two circuit type. If there is a tertiary circuit (tuned-plate circuit) it is sometimes necessary to load that circuit also.

14. Why is a variometer better for a loading inductance than a tapped coil or one with a slider?

Ans. Because finer variations of inductance may be secured with the variometer.

15. What is the advantage of using a condenser in series with the antenna?

Ans. If the condenser is variable the wave length of the antenna may be made closely variable within certain limits. Another advantage is that the ratio of inductance to capacitance may be increased when tuning to a given wave length. An

increase in this ratio means increased selectivity or less liability to interference from stations transmitting on different wave lengths. Close tuning is very desirable, but the necessary adjustments are, of course, increased.

16. Is a vario-coupler better than a loose-coupler for use in a receiving circuit?

Ans. A vario-coupler usually gives the better results because it generally allows a variation of coupling without much separation of the two coils.

17. Is it advisable to use low values of capacitance (capacity) in the secondary condenser for tuning to a given wave length?

Ans. Yes, a predominance of inductance in this circuit for any given wave length is advisable when a vacuum tube detector is used. In any case, the increase in ratio of inductance to capacitance makes for sharper or closer tuning. In the case of very short waves it is often advisable to eliminate the secondary condenser entirely and use a variometer for tuning the grid circuit of a vacuum tube detector. In the case of crystal detector reception the elimination of the secondary condenser will often increase the signal strength but decrease to some extent the sharpness of tuning.

18. Will the use of a loading coil decrease the range of reception?

Ans. Not so long as the resistance of the winding is not too high. In practice it will not reduce the range, nor will it increase it.

19. Is it advisable to burn a vacuum tube filament very brightly?

Ans. No, it is not advisable to burn it any more brightly than is absolutely necessary. Burning it less brightly increases its life and very often a weaker signal in the head-phones is

more advisable than a very brilliantly glowing filament. It has been found that if a filament is operated with a constant voltage between its terminals its life is very greatly increased.

20. May alternating current be used to light a filament?

Ans. It is not advisable in the case of a receiver because there is usually an annoying hum even when precautions are taken to eliminate it. Furthermore, a step down transformer is necessary, as a tube filament would be promptly burned out if connected to a 110 volt alternating current circuit. The voltage from the transformer secondary should be six volts and a potentiometer may be connected directly across the filament leads with the potentiometer slider connected to the grid circuit. The grid circuit is not then connected to one side of the filament, but rather to a point on the potentiometer resistance which gives a zero potential of grid with respect to filament at any instant. This theoretical result is difficult to attain in practice and there are many other considerations. It is usually more advisable to use a storage battery for filament lighting than any other known source of energy.

21. May alternating current be used for the plate circuit of a tube?

Ans. Never in a receiving set, because it would be practically impossible to eliminate the hum even with an elaborate filtering arrangement. It may be used very satisfactorily in the case of tube transmitters, particularly telegraph transmitters.

22. May an amplifier be used with a crystal detector?

Ans. Yes, providing the input terminals of the amplifier are connected into the circuit where the head-phones would otherwise be.

23. What is the advantage of regeneration?

Ans. It increases the strength of the signals heard in the head-phones by feeding back energy from the plate to the grid circuit and reinforcing the potential variations applied to the grid. If the regeneration is great enough, local oscillations are self-generated, and undamped wave telegraph signals may be made audible by the beat method.

24. What is the disadvantage of regeneration in the reception of voice and music?

Ans. The delicate overtones and harmonics are usually lost, and if too much regeneration is used the voice and music are distorted.

25. What is the squealing noise sometimes heard with a regenerative receiver?

Ans. It is usually caused by too much regeneration and is the result of beat production produced by oscillations of different frequencies. These oscillations are self-generated in the circuits. Howling may be caused by circuits being run too close to each other. The wiring of plate and grid circuits should be separated from each other. Howling is often caused by incorrect adjustment of plate battery voltage.

26. Is a soft tube better than a hard tube for a detector?

Ans. The soft tube is more sensitive, but requires a very critical adjustment of filament current and plate battery voltage. The hard tube is somewhat less sensitive, but is very much easier to maintain in adjustment.

27. Why is it that a whistling noise is sometimes noticed when receiving from a radio-telephone station, no change having been made in the receiver or amplifier adjustments?

Ans. This is invariably caused by another station radiating continuous waves just different enough from those being received to produce a beat tone which sounds like a whistle. Sometimes these interfering oscillations are produced by a

nearby receiving station which is using regeneration and radiating some of the energy of the locally generated oscillations.

28. Why does placing the hands near the panel of a regenerative receiver change the signals?

Ans. Because there is a capacity effect of the body added to that of the receiver circuits. This changes the tuning. If the receiver were properly shielded this effect would not be noticed. Instead of shielding, circuits are often arranged in such a manner as to obviate the difficulty. No properly designed regenerative receiver will give this kind of trouble.

29. How can the "frying" noise sometimes heard with a soft detector tube be avoided?

Ans. By never allowing the filament to burn too brightly.

30. Will one filament lighting battery be sufficient for a vacuum tube detector and two stage amplifier?

Ans. Yes, one storage battery of the proper voltage and ampere-hour capacity is all that is required. The voltage should be six volts and the capacity either sixty or eighty ampere-hours. The larger battery is preferable if the receiver is to be used much and will not have to be charged as often as the smaller. A 100 ampere-hour battery is not too large, but it is more expensive.

31. In a simple tube detector circuit (no regeneration) why is the negative plate battery lead sometimes connected to the positive filament lead?

Ans. The filament battery voltage adds somewhat to the plate battery voltage and the plate potential is thereby increased.

32. What is the difference between a damped and an undamped wave?

Ans. The amplitudes of the damped waves decrease from a maximum to zero value, whereas those of an undamped wave do not decrease but are always the same.

33. What is meant by a wave train or group of damped waves?

Ans. It is a group of oscillations which diminish in amplitude to a zero value. The amplitudes diminish because they are damped, that is because energy is lost during each reversal of current.

34. Why is normal negative potential applied to the grid of an amplifier tube?

Ans. To avoid a grid current and to bring the operating point to the straight portion of the characteristic curve with a moderate value of plate potential. In the case of some tubes it is not necessary to do this if the plate potential and filament current are properly adjusted.

35. Why is a grid condenser used?

Ans. To avoid the use of a grid battery or other means of fixing the normal grid potential and also to operate the tube on the straight portion of the tube without eliminating the detector action. The latter would reduce the possibility of tube blocking because of large grid potential amplitude in the negative direction.

36. Why is it necessary to tune a receiving antenna circuit?

Ans. In order to produce in it the maximum possible amplitudes of signal current. In other words, to increase the strength of the received signal.

37. Why is it necessary to tune a secondary circuit?

Ans. To secure resonance between it and the antenna circuit and thereby increase the effect of the received signal upon a detector. Also to increase the selectivity of the receiver, providing the coupling is not too great.

38. Why is it desirable to have variable coupling between an antenna and secondary circuit?

Ans. To vary the selectivity of the receiver and to make

possible the elimination of unwanted signals on different wave lengths.

39. Which is better for selectivity, close or loose coupling between the two circuits mentioned?

Ans. Loose coupling.

40. When is close coupling used?

Ans. When it is desired to stand by for a call from a transmitting station or to "pick up" a station without knowing just what adjustments are necessary. The station may be picked up more quickly with close coupling. Also, when the signal is too weak to be heard with loose coupling.

41. May a "loud-speaker" be used with a crystal detector alone?

Ans. No, because the energy is not great enough to properly operate it. The signal must be amplified first.

42. May regeneration be accomplished in a crystal detector circuit?

Ans. No, not ordinarily. A vacuum tube is much better.

43. What are ether waves?

Ans. Ether waves are vibrations in the all pervading medium called ether. They are quite similar to water waves which are vibrations of water.

44. How fast do ether waves travel?

Ans. At the rate of 300,000,000 meters (approx. 186,000 miles) per second.

45. Are ether waves only produced electrically?

Ans. No, they may also be produced by heat and light, but in these cases the frequencies of the ether vibrations are very much different.

46. How may the tubes of a radio-frequency cascade amplifier be coupled together?

Ans. By means of resistances or specially designed trans-

formers. They may also be coupled by means of air core choke coils or air core coupling coils.

47. How may the tubes of an audio-frequency cascade amplifier be coupled together?

Ans. Usually by means of iron core transformers, although iron core reactances (choke coils) may also be used.

48. Is it advisable to operate a tube filament with constant current or constant voltage?

Ans. The latter because the filament life is thereby increased.

49. How is the filament current controlled?

Ans. By means of the filament rheostat.

50. What effect upon the current has an increase of resistance in a circuit?

Ans. The current decreases with increase of resistance providing the E. M. F. is kept constant.

51. What are electrons?

Ans. They are negative charges of electricity, the smallest possible particles of negative electricity. They are also current carriers when in motion between two points of different potential in any circuit.

52. What happens when the plate voltage is increased so that it will attract electrons as rapidly as they are emitted by the filament?

Ans. If the filament temperature is constant the plate current stops increasing no matter how much more the plate voltage is increased.

53. What happens when the plate voltage is kept constant and the filament temperature is gradually increased?

Ans. Up to a certain value of filament temperature the plate will attract electrons to it as fast as they are emitted. There will come a time, however, when the plate is unable to attract them at any greater rate unless its voltage increased.

Then, no matter what the increase in filament temperature, the plate current will not be any further increased.

54. If the plate is already attracting electrons at as great a rate as possible will an increase of grid potential affect the plate current?

Ans. No; because there can be no further increase in plate current due to attractive force exerted upon electrons.

55. How is the filament temperature increased or decreased?

Ans. By increasing or decreasing the filament current.

56. How is the plate potential increased or decreased, regardless of the grid?

Ans. By increasing or decreasing the plate battery voltage.

57. Why is it necessary to operate an amplifier tube with the proper value of plate potential and normal grid potential?

Ans. So that the operating point may be brought to the straight portion of the characteristic curve where equal variations of grid potential will produce proportional or symmetrical variations of plate current.

58. In this case why may the filament current not be varied?

Ans. Because, as has been stated, it is advisable to operate the filament at a constant potential and variations of any consequence should not be made in filament current unless they result in its reduction.

59. Is it desirable to have a step up of voltage from primary to secondary of an amplifier coupling transformer?

Ans. Yes, this is desirable, and the transformer should be designed to operate best with the particular tubes to be used.

60. What happens when the plate battery voltage is increased too greatly without any other changes being made?

Ans. The normal plate current may be made so great that saturation is reached and the grid potential variations have no effect upon it. Or, the operating point may be upon the upper

bend of the characteristic curve and distortion may take place in the case of amplification. In any event there is considerable useless drain on the plate battery. If the normal potential of the grid were made negative or more negative the operating point would be brought lower and, with it, the normal plate current.

INDEX

A

"A" Battery, 43
Aerial, 31
Alternating Current, 19
Alternating Current, Radio Frequency, 28
Ampere, 17
Amplification, 76
Amplification, Audio Frequency, 80
Amplification, Cascade, 82
Amplification Factor, 79
Amplification, Radio Frequency, 83
Amplification, Radio Frequency Regenerative, 85
Amplifier, Audio Frequency, 103
Amplifier, Radio and Audio Frequency, 107
Amplifier, Radio Frequency, Resistance Coupled, 104
Amplifier, Radio Frequency, Transformer Coupled, 105
Amplitude, 28
Antenna, 31
Antenna as a Complete Circuit, 35
Armstrong Circuits, 87
Atom, 71
Audio Frequency, 62
Audio Frequency Amplification, 80
Audio Frequency Amplifier, 103
Autodyne, Production of Beats, 87

B

"B" Battery, 42
Battery, Electrical, 16
Battery, Grid, 49
Battery, Plate, 42
Beat, Zero, 88
Beats, 74
Blocking of Tube, 68
By-pass Condenser, 108

C

Coupling, 87
Coupling, Capacitive, 91
Coupling, Conductive, 91
Coupling, Inductive, 91
Coupling, Methods of, 90
Coupling Transformer, 80, 105
Constant, Dielectric, 24
Continuous Oscillations, 28
Construction of Vacuum Tubes, 38
Current, Alternating, 19
Current, Direct, 18
Current of Electricity, 15
Current, Pulsating, 19
Current Strength, 17
Cut-off Potential, 51
C. W.—(Continuous waves), 97
Capacity, 22
Capacitance, 22
Capacitive Coupling, 91
Capacitive Reactance, 23
Capacitance, Tube, 91
Capacitance, Variable, 24
Cascade Amplification, 82
Characteristic Curve, 52
Choking of Tube, 68
Circuit, 15
Circuit, Schematic for Production of Beats, 74
Circuit, Primary, 90
Circuit, Secondary, 90
Circuit, Tertiary, 101
Condenser, 23
Condenser, By-pass, 108
Condenser, Grid, 66
Condenser Effect in Antenna, 36
Conductive Coupling, 91

D

Damped Oscillations, 29
Detection, Simple, 60
Detection with Grid Condenser, 66
Detector Tube, Gas Content, 71

Dielectric, 24
 Dielectric Constant, 24
 Direct Current, 18
 Distortion, Caused by Improper
 Grid Potential, 111
 Distortion, Caused by Overload-
 ing of Tubes, 113
 Distortion, Caused by Too Great
 Regeneration, 113
 Distortion, in Amplifier Trans-
 formers, 111
 Distortion in Amplifier Tube, 76
 Distortion, in Telephone Receiver,
 114

E

Edison Effect, 42
 Effect of Gas in a Detector Tube,
 71
 Electrical Battery, 16
 Electrical Circuit, 15
 Electrical Current, 15
 Electrical Pressure, 17
 Electrical Resistance, 18
 Electrical Resonance, 27
 Electro-motive Force, 17
 Electro-motive Force, Pulsating,
 19
 Electro-motive Force, Steady, 18
 Electron, 44
 Electron Emission from a Heated
 Filament, 44
 E.M.F. (Electro-motive Force), 17
 Ether, 32
 Ether Oscillations, 32
 Ether Vibrations, 32
 Ether Waves, 32

F

Feed-back, 85, 86
 Filament Battery, 43
 Filament Construction, 39
 Filament Current, Influence on
 Plate Current, 47
 Filament Temperature Dependant
 Upon Filament Current, 43
 Forced Oscillations, 90
 Frequency, 20
 Frequency, Audio, 62
 Frequency, Resonance, 34
 Frequency, Tone, 65

G

Gas in a Detector Tube, 71

Grid Battery, 49
 Grid Charge, 49
 Grid Charge, Leakage of, 68
 Grid Condenser, 66
 Grid Construction, 40
 Grid Leak Resistance, 70
 Grid Potential, Influence on Plate
 Current, 49
 Grid Variometer, 101

H

Heterodyne Action, 73
 Heterodyne, Self, 88
 Heterodyne, Separate, 73, 88

I

Inherent Amplification, 76
 Inductance, 21
 Inductance, Loading, 95
 Inductance, Mutual, 91
 Induction, 30
 Inductive Coupling, 91
 Inductive Reactance, 22
 Inter-electrode Tube Capacitance,
 91
 Ion, 72
 Ionization, 72

L

Leakage, of Air Into Tube, 42
 Leakage of Grid Charge, 68
 Loading Inductance, 95

M

Modulation, 64
 Methods of Coupling, 90
 Mutual Inductance, 91*

N

Normal Grid Potential, 56, 82
 Normal Plate Current, 53

O

Ohm, 18
 Ohm's Law, 18
 Operation of Practical Circuits, 94
 Operating Point, 57
 Oscillations, 28
 Oscillations, Continuous, 28
 Oscillations, Damped, 29

Oscillations, Forced, 90
 Oscillations in Ether, 32
 Oscillations, Undamped, 28

P

Plate Battery, 42
 Plate Construction, 40
 Plate Current Dependent Upon
 Filament Current, 47
 Plate Current Dependant Upon
 Grid Potential, 49
 Plate Current Dependant Upon
 Plate Potential, 46
 Plate Current, Normal, 53
 Plate Potential, Influence on Plate
 Current, 46
 Plate Variometer, 101
 Potential, 44
 Potential, Negative, 44
 Potential, Positive, 44
 Practical Circuits, 94
 Primary Circuit, 90
 Principle of Heterodyne Action,
 73
 Pulsating Current, 19

Q

Questions and Answers, 116

R

Radio Frequencies, 21
 Radio Frequency Alternating Cur-
 rent, 28
 Radio Frequency Amplification,
 83
 Radio Frequency Amplifier, Re-
 sistance Coupled, 104
 Radio Frequency Amplifier,
 Transformer Coupling, 105
 Radio Frequency Amplifier with
 Detector and Audio-frequency
 Amplifier, 107
 Radio Frequency Regenerative
 Amplification, 85
 Rate of Flow of Electric Current,
 17
 Reactance, 21
 Reactance, Capacitive, 23
 Reactance, Inductive, 22
 Receiver for Weak Signals, a Sug-
 gestion, 109
 Receiver, Single Circuit, No Re-
 generation, 94

Receiver, Single Circuit, Regen-
 erative, 96
 Receiver, Telephone, 59
 Receiver, Three Circuit Regenera-
 tive for Short and Medium
 Waves, 102
 Receiver, Three Circuit Regenera-
 tive for Short Waves, 101
 Receiver, Two Circuit, Inductive
 Coupling, No Regeneration, 98
 Receiver, Two Circuit, With
 Radio Frequency Amplifier, 106
 Receiver, Two Circuit, with Two
 Stage Audio Frequency Ampli-
 fier, 103

R

Receptacles, 42
 Rectification, 53
 Rectification, Actual, 56
 Rectification, Apparent, 54
 Regenerative Amplification, Radio
 Frequency, 85
 Relay Action, 52
 Resistance, 18
 Resistance, Grid Leak, 70
 Resistance, Variable, 43
 Resonance, 27
 Resonance Frequency, 34
 Rheostat, 43
 Rotor, of Variometer, 91

S

Saturation Point, 50
 Secondary Circuit, 90
 Secondary, Untuned, 95
 Self-heterodyne, 88
 Self-inductance, 21
 Sensitiveness of Detector Tube
 Dependant on Applied Poten-
 tial, 83
 Seperate Heterodyne, 88
 Simple Detection, 60
 Single Circuit Receiver, No Re-
 generation, 94
 Single Circuit, Regenerative Re-
 ceiver, 96
 generative Receiver, 96
 Space Charge, 48
 Space Charge Effect, 48
 Speed of Light, 32
 Sockets, 42
 Stator, of Variometer, 91
 Stiffening a Circuit, 95

T

Telephone Receiver, 59
 Tertiary Circuit, 101
 Three Circuit Regenerative Receiver for Short and Medium Waves, 102
 Three Circuit Regenerative Receiver for Short Waves, 101
 Tickler, 96
 Tone Frequency, 65
 Train of Damped Oscillations, 29
 Transformer Coupling, 80, 105
 Two Circuit Receiver, Inductive Coupling, No Regeneration, 98
 Two Circuit Receiver With Two Stage Audio-frequency Amplifier, 103
 Two Circuit Regenerative Receiver, Inductive Coupling, 100
 Tube Blocking, 68
 Tube Capacitance, 91
 Tube Choking, 68
 Tube Construction, 38
 Tuning the Receiving Antenna, 33

U

Undamped Oscillations, 28

Untuned Secondary, 95

V

Vacuum, 38
 Vacuum Tube, 38
 Vacuum Tube Amplifier, 76
 Vacuum Tube as a Rectifier and Relay, 38
 Vacuum Tube Detector, 59
 Variable Capacitance, 24
 Variable Resistance, 43
 Variometer, 91
 Variometer, Grid, 101
 Variometer, Plate, 101
 Velocity of Ether Waves, 32
 Voice Distortion, 111
 Volt, 18
 Voltage, 18
 Voltage Amplification Factor, 79

W

Wave Length, 32

Z

Zero Beat, 88

L A T E S T
REVISED
CATALOGUE

of the Best

Practical and Mechanical Books

Including Automobile and Aviation Books

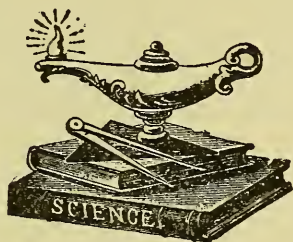

PRACTICAL BOOKS FOR PRACTICAL MEN

Each Book in this Catalogue is written by an
Expert and is written so you can understand it

PUBLISHED BY

THE NORMAN W. HENLEY PUBLISHING CO.

2 West 45th Street, New York, U. S. A.

Established 1890

 Any Book in this Catalogue sent prepaid on receipt of price

Manuscripts solicited on Practical Subjects

INDEX

	PAGE		PAGE
Abrasives and Abrasive Wheels	29	Lathe Work	23
Accidents	25	Link Motions	24
Air Brakes	24, 26	Liquid Air	24
Arithmetic	13, 27, 37	Locomotive Boilers	25
Automobile Books	3, 4, 5, 6	Locomotive Breakdowns	25
Automobile Charts	6, 7	Locomotive Engineering	24, 25, 26
Automobile Ignition Systems	7	Machinist Books	27, 28, 29
Automobile Lighting	4	Manual Training	30
Automobile Questions and Answers	5	Marine Engineering	30
Automobile Repairing	5	Marine Gasoline Engines	21
Automobile Starting Systems	4	Mechanical Drawing	13
Automobile Trouble Charts	6, 7	Mechanical Movements	28
Automobile Welding	6	Metal Work	12
Aviation	8	Model Making	29
Bells, Electric	14	Motor Boats	30
Bevel Gear	21	Motorcycles	7, 31
Boats, Motor	30	Motor Truck	3
Boiler Room Chart	9	Naval Engineering	30
Boilers, Marine	30	Patents	22
Brazing	9	Pattern Making	31
Cams	21	Perfumery	32
Carburetion Trouble Charts	7	Perspective	13
Carburetors	4	Plumbing	32, 33
Car Charts	9	Punches	12
Cements	12	Producer Gas	21
Change Gear	21	Questions and Answers on Automobile	5
Charts	6, 7, 9	Questions on Heating	38
Chemistry	10	Radio Time Signal Receiver	16, 17
Coal	24	Railroad Accidents	25
Combustion	19	Railroad Charts	9
Concrete	10, 11, 12	Recipe Book	34
Concrete for Farm Use	11	Refrigeration	22
Concrete for Shop Use	11	Repairing Automobiles	5
Cosmetics	32	Rope Work	23
Dictionary	12, 17	Rubber	35
Dies	12	Rubber Stamps	35
Drawing	13, 32	Saw Filing	35
Drawing for Plumbers	32	Saws, Management of	35
Dynamo Building	14	Screw Cutting	35
Electric Bells	14	Shipbuilders' Pocket Book	30
Electric Dictionary	17	Shop Construction	27
Electric Switchboards	15	Shop Management	27
Electric Toy Making	16	Shop Practice	27, 28, 29
Electric Wiring	15	Shop Tools	29
Electricity	13, 14, 15, 16, 17, 18	Sketching Paper	13
Electroplating	19	Slide Valve	24
Encyclopedia	29	Soldering	9
Engine, Aviation	8	Splices and Rope Work	23
E-T Air Brake	26	Steam Engineering	35, 36, 37
Factory Management	19	Steam Heating	37
Ford Automobile	4	Steel	38
Ford Tractor	4	Storage Batteries	18
Ford Trouble Chart	7	Submarine Chart	9
Formulas and Recipes	34	Switchboards	15
Fuel	19	Tapers	23
Gas Engines	20, 21	Telegraphy, Wireless	14, 16, 18
Gas Tractor	39	Telephone	18
Gearing and Cams	21	Thread-Cutting	27
Glossary Aviation Terms	8	Tool Making	27
Heating	37	Tool Steel	38
High Frequency Apparatus	15	Toy Making	16
Horse-Power Chart	36	Tractive Power Chart	9
Hot Water Heating	37	Tractor, Gas	39
House Wiring	17, 18	Train Rules	26
Hydraulics	22	Vacuum Heating	38
Ice	22	Valve Setting	24
Ignition Systems	4	Ventilation	37
Ignition Trouble Chart	7	Walschaert Valve Gear	26
India Rubber	35	Waterproofing	12
Interchangeable Manufacturing	27	Welding	6, 39
Inventions	22	Wireless Telegraphy	14, 16, 18
Kerosene Carburetors	4	Wiring	15, 17, 18
Knots	23	Wiring Diagrams	15

Any of these books promptly sent prepaid to any address in the world on receipt of price.

HOW TO REMIT.—By Postal Money Order, Express Money Order, Bank Draft or Registered Letter.

AUTOMOBILES

THE MODERN GASOLINE AUTOMOBILE—ITS DESIGN, CONSTRUCTION, MAINTENANCE AND REPAIR. By VICTOR W. PAGÉ, M.E.

The latest and most complete treatise on the Gasoline Automobile ever issued. Written in simple language by a recognized authority, familiar with every branch of the automobile industry. Free from technical terms. Everything is explained so simply that anyone of average intelligence may gain a comprehensive knowledge of the gasoline automobile. The information is up-to-date and includes, in addition to an exposition of principles of construction and description of all types of automobiles and their components, valuable money-saving hints on the care and operation of motor-cars propelled by internal combustion engines. Among some of the subjects treated might be mentioned: Torpedo and other symmetrical body forms designed to reduce air resistance; sleeve valve, rotary valve and other types of silent motors; increasing tendency to favor worm-gear power-transmission; universal application of magneto ignition; development of automobile electric-lighting systems; block motors; underslung chassis; application of practical self-starters; long stroke and offset cylinder motors; latest automatic lubrication systems; silent chains for valve operation and change-speed gearing; the use of front wheel brakes and many other detail refinements. By a careful study of the pages of this book one can gain practical knowledge of automobile construction that will save time, money and worry. The book tells you just what to do, how and when to do it. Nothing has been omitted, no detail has been slighted. Every part of the automobile, its equipment, accessories, tools, supplies, spare parts necessary, etc., have been discussed comprehensively. If you are or intend to become a motorist, or are in any way interested in the modern Gasoline Automobile, this is a book you cannot afford to be without. 1032 pages—and more than 1,000 new and specially made detail illustrations, as well as many full-page and double-page plates, showing all parts of the automobile. Including 12 large folding plates. New Edition. Price \$4.00

WHAT IS SAID OF THIS BOOK:

- “It is the best book on the Automobile seen up to date.”—J. H. Pile, Associate Editor *Automobile Trade Journal*.
- “Every Automobile Owner has use for a book of this character.”—*The Tradesman*.
- “This book is superior to any treatise heretofore published on the subject.”—*The Inventive Age*.
- “We know of no other volume that is so complete in all its departments, and in which the wide field of automobile construction with its mechanical intricacies is so plainly handled, both in the text and in the matter of illustrations.”—*The Motorist*.
- “The book is very thorough, a careful examination failing to disclose any point in connection with the automobile, its care and repair, to have been overlooked.”—*Iron Age*.
- “Mr. Pagé has done a great work, and benefit to the Automobile Field.”—W. O. Hasford, Mgr. Y. M. C. A. Automobile School, Boston, Mass.
- “It is just the kind of a book a motorist needs if he wants to understand his car.”—*American Thresherman*.

THE MODERN MOTOR TRUCK, ITS DESIGN, CONSTRUCTION, OPERATION AND REPAIR. By VICTOR W. PAGÉ.

Just off the press and treats on all types of motor trucks and industrial tractors and trailers. It considers all types of trucks, gasoline and electric, and all varieties of truck bodies. This book is written in language everyone can understand and is not in any sense of the word a technical treatise. It is a practical volume that will make special appeal to the truck driver who seeks to better his position and to the mechanic charged with the repair and upkeep of trucks. The factory or business executive who wants to obtain a complete working knowledge of truck operation problems will find this book a reference work of great value. The truck salesman or automobile dealer will find that this work contains information that means money to them. All garage and service station men should have a copy of this book for reference because truck construction differs from passenger car design in many important respects. Anyone who reads this book is in touch with all the practical features that have been tested out in real service. 1921 Edition. Cloth, 6 x 9, 962 pages, 750 illustrations Price. \$5.00

CATALOGUE OF GOOD, PRACTICAL BOOKS

THE MODEL T FORD CAR, ITS CONSTRUCTION, OPERATION AND REPAIR, INCLUDING THE FORDSON FARM TRACTOR, F. A. LIGHTING AND STARTING SYSTEM, FORD MOTOR TRUCK. By VICTOR W. PAGÉ.

This is the most complete and practical instruction book ever published on the Ford car and Fordson tractor. All parts of the Ford Model T car and Fordson tractor are described and illustrated in a comprehensive manner. The construction is fully treated and operating principle made clear to everyone. Complete instructions for driving and repairing are given. To the New Revised Edition matter has been added on the Ford Truck and Tractor Conversion Sets and Genuine Fordson Tractor. All parts are described. All repair processes illustrated and fully explained. Written so all can understand—no theory, no guesswork. New revised and enlarged Edition just published. 153 illustrations, 410 pages, 2 large folding plates. Price . \$2.00

AUTOMOBILE STARTING, LIGHTING AND IGNITION SYSTEMS. By VICTOR W. PAGÉ, M.E.

This practical volume has been written with special reference to the requirements of the non-technical reader desiring easily understood, explanatory matter, relating to all types of automobile ignition, starting and lighting systems. It can be understood by anyone, even without electrical knowledge, because elementary electrical principles are considered before any attempt is made to discuss features of the various systems. These basic principles are clearly stated and illustrated with simple diagrams. *All the leading systems of starting, lighting and ignition have been described and illustrated with the co-operation of the experts employed by the manufacturers.* Wiring diagrams are shown in both technical and non-technical forms. All symbols are fully explained. It is a comprehensive review of modern starting and ignition system practice, and includes a complete exposition of storage battery construction, care and repair. All types of starting motors, generators, magnetos, and all ignition or lighting system units are fully explained. The systems of cars already in use as well as those that are to come are considered. *Every person in the automobile business needs this volume.* 5¼x7½. Cloth. 815 pages, 492 illustrations, 3 folding plates. New revised and enlarged edition. Price \$3.00

GASOLINE AND KEROSENE CARBURETORS, CONSTRUCTION, INSTALLATION AND ADJUSTMENT. By VICTOR W. PAGÉ. A new up-to-date Book on Modern Carburetion Practice.

This is a simple, comprehensive, and authoritative treatise for practical men explaining all basic principles pertaining to carburetion, showing how liquid fuels are vaporized and turned into gas for operating all types of internal combustion engines intended to operate on vapors of gasoline, kerosene, benzol, and alcohol. All leading types of carburetors are described in detail, special attention being given to the forms devised to use the cheaper fuels such as kerosene. Carburetion troubles, fuel system troubles, carburetor repairs and installation, electric primers and economizers, hot spot manifolds and all modern carburetor developments are considered in a thorough manner. Methods of adjusting all types of carburetors are fully discussed as well as suggestions for securing maximum fuel economy and obtaining highest engine power. This book is invaluable to repairmen, students, and motorists, as it includes the most complete exposition on kerosene carburetors ever published. The drawings showing carburetor construction are made from accurate engineering designs and show all parts of late types of carburetors. 213 pages. 89 illustrations. . \$2.00

HINTS AND TIPS FOR AUTOMOBILISTS. By VICTOR W. PAGÉ.

The book is ideal for the busy man or woman who wants to know about car operation and upkeep because of the economies possible when an automobile is intelligently operated. It contains many money-saving hints and a brief simple exposition of location and remedy of roadside troubles apt to occur under ordinary operating conditions. Price 75 cents

CATALOGUE OF GOOD, PRACTICAL BOOKS

AUTOMOBILE REPAIRING MADE EASY. By VICTOR W. PAGÉ, M.E.

A comprehensive, practical exposition of every phase of modern automobile repairing practice. Outlines every process incidental to motor car restoration. Gives plans for workshop construction, suggestions for equipment, power needed, machinery and tools necessary to carry on the business successfully. Tells how to overhaul and repair all parts of all automobiles. Everything is explained so simply that motorists and students can acquire a full working knowledge of automobile repairing. This work starts with the engine, then considers carburetion, ignition, cooling and lubrication systems. The clutch, change-speed gearing and transmission system are considered in detail. Contains instructions for repairing all types of axles, steering gears and other chassis parts. Many tables, short cuts in figuring and rules of practice are given for the mechanic. Explains fully valve and magneto timing, "tuning" engines, systematic location of trouble, repair of ball and roller bearings, shop kinks, first aid to injured and a multitude of subjects of interest to all in the garage and repair business.

This book contains special instructions on electric starting, lighting and ignition systems, tire repairing and rebuilding, autogenous welding, brazing and soldering, heat treatment of steel, latest timing practice, eight and twelve-cylinder motors, etc. 5¼x8. Cloth. 1060 pages, 1,000 illustrations, 11 folding plates. Price. \$4.00

WHAT IS SAID OF THIS BOOK:

"'Automobile Repairing Made Easy' is the best book on the subject I have ever seen and the only book I ever saw that is of any value in a garage."—Fred Jeffrey, Martinsburg, Neb.

"I wish to thank you for sending me a copy of 'Automobile Repairing Made Easy.' I do not think it could be excelled."—S. W. Gisriel, Director of Instruction, Y. M. C. A., Philadelphia, Pa.

QUESTIONS AND ANSWERS RELATING TO MODERN AUTOMOBILE CONSTRUCTION, DRIVING AND REPAIR. By VICTOR W. PAGÉ, M.E.

A practical self-instructor for students, mechanics and motorists, consisting of thirty-seven lessons in the form of questions and answers, written with special reference to the requirements of the non-technical reader desiring easily understood, explanatory matter relating to all branches of automobiling. The subject-matter is absolutely correct and explained in simple language. If you can't answer all of the following questions, you need this work. The answers to these and nearly 2000 more are to be found in its pages. Give the name of all important parts of an automobile and describe their functions? Describe action of latest types of kerosene carburetors? What is the difference between a "double" ignition system and a "dual" ignition system? Name parts of an induction coil? How are valves timed? What is an electric motor starter and how does it work? What are advantages of worm drive gearing? Name all important types of ball and roller bearings? What is a "three-quarter" floating axle? What is a two-speed axle? What is the Vulcan electric gear shift? Name the causes of lost power in automobiles? Describe all noises due to deranged mechanism and give causes? How can you adjust a carburetor for the color of the exhaust gases? What causes "popping" in the carburetor? What tools and supplies are needed to equip a car? How do you drive various makes of cars? What is a differential lock and where is it used? Name different systems of wire wheel construction, etc., etc. A popular work at a popular price. 5¼x7½. Cloth. 701 pages, 387 illustrations, 3 folding plates. New revised edition. Price \$2.50

WHAT IS SAID OF THIS BOOK:

"If you own a car—get this book."—*The Glassworker*.

"Mr. Pagé has the faculty of making difficult subjects plain and understandable."—*Bristol Press*.

"We can name no writer better qualified to prepare a book of instruction on automobiles than Mr. Victor W. Pagé."—*Scientific American*.

"The best automobile catechism that has appeared."—*Automobile Topics*.

"There are few men, even with long experience, who will not find this book useful. Great pains have been taken to make it accurate. Special recommendation must be given to the illustrations, which have been made specially for the work. Such excellent books as this greatly assist in fully understanding your automobile."—*Engineering News*.

CATALOGUE OF GOOD, PRACTICAL BOOKS

HOW TO RUN AN AUTOMOBILE. By VICTOR W. PAGÉ.

This treatise gives concise instructions for starting and running all makes of gasoline automobiles, how to care for them, and gives distinctive features of control. Describes every step for shifting gears, controlling engine, etc. Among the chapters contained are: I. Automobile Parts and Their Functions. II. General Starting and Driving Instructions. III. Control Systems—Care of Automobiles. Thoroughly illustrated. 178 pages. 72 illustrations. Price \$1.50

THE AUTOMOBILIST'S POCKET COMPANION AND EXPENSE RECORD. By VICTOR W. PAGÉ.

This book is not only valuable as a convenient cost record, but contains much information of value to motorists. Includes a condensed digest of auto laws of all States, a lubrication schedule, hints for care of storage battery, and care of tires, location of road troubles, anti-freezing solutions, horse-power table, driving hints and many useful tables and recipes of interest to all motorists. Not a technical book in any sense of the word, just a collection of practical facts in simple language for the every-day motorist. Convenient pocket size. Price \$1.50

AUTOMOBILE WELDING WITH THE OXY-ACETYLENE FLAME. By M. KEITH DUNHAM.

Explains in a simple manner apparatus to be used, its care, and how to construct necessary shop equipment. Proceeds then to the actual welding of all automobile parts, in a manner understandable by everyone. Gives principles never to be forgotten. This book is of utmost value, since the perplexing problems arising when metal is heated to a melting point are fully explained and the proper methods to overcome them shown. 167 pages. Fully illustrated. Price. \$1.50

AUTOMOBILE, AVIATION AND MOTORCYCLE CHARTS

AVIATION CHART—LOCATION OF AIRPLANE POWER PLANT TROUBLES MADE EASY. By MAJOR VICTOR W. PAGÉ, A.S., S.C.U.S.R.

A large chart outlining all parts of a typical airplane power plant, showing the points where a trouble is apt to occur and suggesting remedies for the common defects. Intended especially for aviators and aviation mechanics on school and field duty. Price 35 cents

CHART. GASOLINE ENGINE TROUBLES MADE EASY—A CHART SHOWING SECTIONAL VIEW OF GASOLINE ENGINE. Compiled by VICTOR W. PAGÉ, M.E.

It shows clearly all parts of a typical four-cylinder gasoline engine of the four-cycle type. It outlines distinctly all parts liable to give trouble and also details the derangements apt to interfere with smooth engine operation. Valuable to students, motorists, mechanics, repairmen, garagemen, automobile salesmen, chauffeurs, motorboat owners, motor-truck and tractor drivers, aviators, motorcyclists, and all others who have to do with gasoline power plants. It simplifies location of all engine troubles, and while it will prove invaluable to the novice, it can be used to advantage by the more expert. It should be on the walls of every public and private garage, automobile repair shop, club house or school. It can be carried in the automobile or pocket with ease, and will insure against loss of time when engine trouble manifests itself. This sectional view of engine is a complete review of all motor troubles. It is prepared by a practical motorist for all who motor. More information for the money than ever before offered. No details omitted. Size 25x38 inches. Securely mailed on receipt of 35 cents

CATALOGUE OF GOOD, PRACTICAL BOOKS

CHART. LOCATION OF FORD ENGINE TROUBLES MADE EASY. Compiled by VICTOR W. PAGÉ, M.E.

This shows clear sectional views depicting all portions of the Ford power plant and auxiliary groups. It outlines clearly all parts of the engine, fuel supply system, ignition group and cooling system, that are apt to give trouble, detailing all derangements that are liable to make an engine lose power, start hard or work irregularly. This chart is valuable to students, owners, and drivers, as it simplifies location of all engine faults. Of great advantage as an instructor for the novice, it can be used equally well by the more expert as a work of reference and review. It can be carried in the toolbox or pocket with ease and will save its cost in labor eliminated the first time engine trouble manifests itself. Prepared with special reference to the average man's needs and is a practical review of all motor troubles because it is based on the actual experience of an automobile engineer-mechanic with the mechanism the chart describes. It enables the non-technical owner or operator of a Ford car to locate engine derangements by systematic search, guided by easily recognized symptoms instead of by guesswork. It makes the average owner independent of the roadside repair shop when touring. Must be seen to be appreciated. Size 25x38 inches. Printed on heavy bond paper. Price 35 cents

CHART. LUBRICATION OF THE MOTOR CAR CHASSIS. Compiled by VICTOR W. PAGÉ, M.E.

This chart presents the plan view of a typical six-cylinder chassis of standard design and all parts are clearly indicated that demand oil, also the frequency with which they must be lubricated and the kind of oil to use. A practical chart for all interested in motor-car maintenance. Size 24x38 inches. Price 35 cents

CHART. LOCATION OF CARBURETION TROUBLES MADE EASY. Compiled by VICTOR W. PAGÉ, M.E.

This chart shows all parts of a typical pressure feed fuel supply system and gives causes of trouble, how to locate defects and means of remedying them. Size 24x38 inches. Price 35 cents

CHART. LOCATION OF IGNITION SYSTEM TROUBLES MADE EASY. Compiled by VICTOR W. PAGÉ, M.E.

In this diagram all parts of a typical double ignition system using battery and magneto current are shown, and suggestions are given for readily finding ignition troubles and eliminating them when found. Size 24x38 inches. Price 35 cents

CHART. LOCATION OF COOLING AND LUBRICATION SYSTEM FAULTS. Compiled by VICTOR W. PAGÉ, M.E.

This composite diagram shows a typical automobile power plant using pump circulated water-cooling system and the most popular lubrication method. Gives suggestions for curing all overheating and loss of power faults due to faulty action of the oiling or cooling group. Size 24x38 inches. Price 35 cents

CHART. LOCATION OF STARTING AND LIGHTING SYSTEM FAULTS.

The most complete chart yet devised, showing all parts of the modern automobile starting, lighting and ignition systems, giving instructions for systematic location of all faults in wiring, lamps, motor or generator, switches and all other units. Invaluable to motorists, chauffeurs and repairmen. Size 24x38 inches. Price . 35 cents

CHART. MOTORCYCLE TROUBLES MADE EASY. Compiled by VICTOR W. PAGÉ, M.E.

A chart showing sectional view of a single-cylinder gasoline engine. This chart simplifies location of all power-plant troubles. A single-cylinder motor is shown for simplicity. It outlines distinctly all parts liable to give trouble and also details the derangements apt to interfere with smooth engine operation. This chart will prove of value to all who have to do with the operation, repair or sale of motorcycles. No details omitted. Size 30x20 inches. Price 35 cents

CATALOGUE OF GOOD, PRACTICAL BOOKS

AVIATION

A B C OF AVIATION. By MAJOR VICTOR W. PAGÉ.

This book describes the basic principles of aviation, tells how a balloon or dirigible is made and why it floats in the air. Describes how an airplane flies. It shows in detail the different parts of an airplane, what they are and what they do. Describes all types of airplanes and how they differ in construction; as well as detailing the advantages and disadvantages of different types of aircraft. It includes a complete dictionary of aviation terms and clear drawings of leading airplanes. The reader will find simple instructions for unpacking, setting up, and rigging airplanes. A full description of airplane control principles is given and methods of flying are discussed at length.

This book answers every question one can ask about modern aircraft, their construction and operation. A self-educator on aviation without an equal. 274 pages. 130 specially made illustrations with 7 plates. Price \$2.50

AVIATION ENGINES—DESIGN; CONSTRUCTION; REPAIR. By MAJOR VICTOR W. PAGÉ, A.S., S.C.U.S.R.

This treatise, written by a recognized authority on all of the practical aspects of internal combustion engine construction, maintenance, and repair, fills the need as no other book does. The matter is logically arranged; all descriptive matter is simply expressed and copiously illustrated, so that anyone can understand airplane engine operation and repair even if without previous mechanical training. This work is invaluable for anyone desiring to become an aviator or aviation mechanic. The latest rotary types, such as the Gnome Monosoupape, and LeRhone, are fully explained, as well as the recently developed Vee and radial types. The subjects of carburetion, ignition, cooling, and lubrication also are covered in a thorough manner. The chapters on repair and maintenance are distinctive and found in no other book on this subject. Not a technical book, but a practical, easily understood work of reference for all interested in aeronautical science. 589 pages. 253 illustrations. Price, net \$3.00

GLOSSARY OF AVIATION TERMS—ENGLISH-FRENCH; FRENCH-ENGLISH. By MAJOR VICTOR W. PAGÉ, A.S., S.C.U.S.R., and LIEUT. PAUL MONTARIOL, of the French Flying Corps.

A complete glossary of practically all terms used in aviation, having lists in both French and English with equivalents in either language. Price, net . . . \$1.00

APPLIED AERODYNAMICS. By G. P. THOMPSON.

This is a scientific and mathematical treatise that has a special appeal to the student and engineer who are seeking exact information on the aerodynamics of heavier-than-air craft and data on airplane design testing. This book gives an up-to-date presentation of the existing state of Aeronautical Science. In addition to a very full discussion of the qualities which determine the speed and rate of climb of an aeroplane and the method by which they can be calculated, special attention is paid to stability—a problem now fairly well understood, and to controllability—our knowledge of which is at present in a much more elementary state. Attention is directed to the numerous directions in which further information is required, especially in the form of full-scale experiments. 312 pages (7 x 10). Illustrated with over 142 Diagrams and Graphic Charts. Price \$12.50

AVIATION CHART—LOCATION OF AIRPLANE POWER PLANT TROUBLES MADE EASY. By MAJOR VICTOR W. PAGÉ, A.S., S.C.U.S.R.

A large chart outlining all parts of a typical airplane power plant, showing the points where trouble is apt to occur and suggesting remedies for the common defects. Intended especially for aviators and aviation mechanics on school and field duty. Price 35 cents

BRAZING AND SOLDERING

BRAZING AND SOLDERING. By JAMES F. HOBART.

The only book that shows you just how to handle any job of brazing or soldering that comes along; it tells you what mixture to use, how to make a furnace if you need one. Full of valuable kinks. The fifth edition of this book has just been published, and to it much new matter and a large number of tested formulæ for all kinds of solders and fluxes have been added. Illustrated. 35 cents

SOLDERING AND BRAZING. By RAYMOND FRANCIS YATES.

This treatise gives all the necessary "kinks" that will enable one to accomplish successful soldering. If a mechanic has not succeeded in his soldering, this book may tell him just what he needs to produce good work—something that he may heretofore have forgotten. Price 75 cents

CHARTS

MODERN SUBMARINE CHART.

A cross-section view, showing clearly and distinctly all the interior of a Submarine of the latest type. You get more information from this chart, about the construction and operation of a Submarine, than in any other way. No details omitted—everything is accurate and to scale. All the machinery and devices fitted in a modern Submarine Boat are shown. 35 cents

BOX CAR CHART.

A chart showing the anatomy of a box car, having every part of the car numbered and its proper name given in a reference list. 35 cents

GONDOLA CAR CHART.

A chart showing the anatomy of a gondola car, having every part of the car numbered and its proper reference name given in a reference list. 35 cents

PASSENGER-CAR CHART.

A chart showing the anatomy of a passenger-car, having every part of the car numbered and its proper name given in a reference list. 35 cents

STEEL HOPPER BOTTOM COAL CAR.

A chart showing the anatomy of a steel Hopper Bottom Coal Car, having every part of the car numbered and its proper name given in a reference list. 35 cents

TRACTIVE POWER CHART.

A chart whereby you can find the tractive power or drawbar pull of any locomotive without making a figure. Shows what cylinders are equal, how driving wheels and steam pressure affect the power. What sized engine you need to exert a given drawbar pull or anything you desire in this line. 50 cents

HORSE-POWER CHART

Shows the horse-power of any stationary engine without calculation. No matter what the cylinder diameter or stroke, the steam pressure of cut-off, the revolutions, or whether condensing or non-condensing, it's all there. Easy to use, accurate, and saves time and calculations. Especially useful to engineers and designers. 50 cents

BOILER ROOM CHART. By GEO. L. FOWLER.

A chart—size 14x28 inches—showing in isometric perspective the mechanisms belonging in a modern boiler room. The various parts are shown broken or removed, so that the internal construction is fully illustrated. Each part is given a reference number, and these, with the corresponding name, are given in a glossary printed at the sides. 35 cents

CATALOGUE OF GOOD, PRACTICAL BOOKS

CHEMISTRY

HOW TO MAKE AND USE A SMALL CHEMICAL LABORATORY. By RAYMOND FRANCIS YATES.

The treatise covers all of the essentials of elementary chemistry. The law of definite proportions, solutions, crystalloids, colloids, electrolysis, etc., are explained. The second part of the book is devoted to chemical and electro-chemical experiments. Only those experiments that will tend to broaden the reader's knowledge of chemistry in general have been chosen. Price 75 cents

CONCRETE

JUST PUBLISHED—CONCRETE WORKERS' REFERENCE BOOKS. A SERIES OF POPULAR HANDBOOKS FOR CONCRETE USERS. Prepared by A. A. HOUGHTON. Each 75 cents

The author, in preparing this Series, has not only treated on the usual types of construction, but explains and illustrates molds and systems that are not patented, but which are equal in value and often superior to those restricted by patents. These molds are very easily and cheaply constructed and embody simplicity, rapidity of operation, and the most successful results in the molded concrete. Each of these Twelve books is fully illustrated, and the subjects are exhaustively treated in plain English.

CONCRETE WALL FORMS. By A. A. HOUGHTON.

A new automatic wall clamp is illustrated with working drawings. Other types of wall forms, clamps, separators, etc., are also illustrated and explained. (No. 1 of Series) 75 cents

CONCRETE FLOORS AND SIDEWALKS. By A. A. HOUGHTON.

The molds for molding squares, hexagonal and many other styles of mosaic floor and sidewalk blocks are fully illustrated and explained. (No. 2 of Series) . . . 75 cents

PRACTICAL CONCRETE SILO CONSTRUCTION. By A. A. HOUGHTON.

Complete working drawings and specifications are given for several styles of concrete silos, with illustrations of molds for monolithic and block silos. The tables, data, and information presented in this book are of the utmost value in planning and constructing all forms of concrete silos. (No. 3 of Series) 75 cents

MOLDING CONCRETE CHIMNEYS, SLATE AND ROOF TILES. By A. A. HOUGHTON.

The manufacture of all types of concrete slate and roof tile is fully treated. Valuable data on all forms of reinforced concrete roofs are contained within its pages. The construction of concrete chimneys by block and monolithic systems is fully illustrated and described. A number of ornamental designs of chimney construction with molds are shown in this valuable treatise. (No. 4 of Series.) 75 cents

MOLDING AND CURING ORNAMENTAL CONCRETE. By A. A. HOUGHTON.

The proper proportions of cement and aggregates for various finishes, also the method of thoroughly mixing and placing in the molds, are fully treated. An exhaustive treatise on this subject that every concrete worker will find of daily use and value (No. 5 of Series.) 75 cents

CONCRETE MONUMENTS, MAUSOLEUMS AND BURIAL VAULTS. By A. A. HOUGHTON.

The molding of concrete monuments to imitate the most expensive cut stone is explained in this treatise, with working drawings of easily built molds. Cutting inscriptions and designs are also fully treated. (No. 6 of Series.) . . . 75 cents

CATALOGUE OF GOOD, PRACTICAL BOOKS

MOLDING CONCRETE BATHTUBS, AQUARIUMS AND NATATORIUMS.

By A. A. HOUGHTON.

Simple molds and instruction are given for molding many styles of concrete bathtubs, swimming-pools, etc. These molds are easily built and permit rapid and successful work. (No. 7 of Series.) **75 cents**

CONCRETE BRIDGES, CULVERTS AND SEWERS. By A. A. HOUGHTON.

A number of ornamental concrete bridges with illustrations of molds are given. A collapsible center or core for bridges, culverts and sewers is fully illustrated with detailed instructions for building. (No. 8 of Series.) **75 cents**

CONSTRUCTING CONCRETE PORCHES. By A. A. HOUGHTON.

A number of designs with working drawings of molds are fully explained so anyone can easily construct different styles of ornamental concrete porches without the purchase of expensive molds. (No. 9 of Series.) **75 cents**

MOLDING CONCRETE FLOWER-POTS, BOXES, JARDINIÈRES, ETC.

By A. A. HOUGHTON.

The molds for producing many original designs of flower-pots, urns, flower-boxes, jardinières, etc., are fully illustrated and explained, so the worker can easily construct and operate same. (No. 10 of Series.) **75 cents**

MOLDING CONCRETE FOUNTAINS AND LAWN ORNAMENTS. By A.

A. HOUGHTON.

The molding of a number of designs of lawn seats, curbing, hitching posts, pergolas, sun dials and other forms of ornamental concrete for the ornamentation of lawns and gardens, is fully illustrated and described. (No. 11 of Series) **75 cents**

CONCRETE FROM SAND MOLDS. By A. A. HOUGHTON.

A Practical Work treating on a process which has heretofore been held as a trade secret by the few who possessed it, and which will successfully mold every and any class of ornamental concrete work. The process of molding concrete with sand molds is of the utmost practical value, possessing the manifold advantages of a low cost of molds, the ease and rapidity of operation, perfect details to all ornamental designs, density and increased strength of the concrete, perfect curing of the work without attention and the easy removal of the molds regardless of any undercutting the design may have. 192 pages. Fully illustrated. Price **\$2.00**

ORNAMENTAL CONCRETE WITHOUT MOLDS. By A. A. HOUGHTON.

The process for making ornamental concrete without molds has long been held as a secret, and now, for the first time, this process is given to the public. The book reveals the secret and is the only book published which explains a simple, practical method whereby the concrete worker is enabled, by employing wood and metal templates of different designs, to mold or model in concrete any Cornice, Archivolte, Column, Pedestal, Base Cap, Urn or Pier in a monolithic form—right upon the job. These may be molded in units or blocks, and then built up to suit the specifications demanded. This work is fully illustrated, with detailed engravings. Price . **\$2.00**

CONCRETE FOR THE FARM AND IN THE SHOP. By H. COLIN CAMPBELL, C.E., E.M.

A new book illustrating and describing in plain, simple language many of the numerous applications of concrete within the range of the home worker. Among the subjects treated are:

Principles of reinforcing; methods of protecting concrete so as to insure proper hardening; home-made mixers; mixing by hand and machine; form construction, described and illustrated by drawings and photographs; construction of concrete walls and fences; concrete fence posts; concrete gate posts; corner posts; clothes line posts; grape arbor posts; tanks; troughs; cisterns; hog wallows; feeding floors and barnyard pavements; foundations; well curbs and platforms; indoor floors; sidewalks; steps; concrete hotbeds and cold frames; concrete slab roofs; walls for buildings; repairing leaks in tanks and cisterns, etc., etc. A number of convenient and practical tables for estimating quantities, and some practical examples, are also given. (5 x 7). 149 pages, 51 illustrations. Price **\$1.00**

CATALOGUE OF GOOD, PRACTICAL BOOKS

POPULAR HANDBOOK FOR CEMENT AND CONCRETE USERS. By MYRON H. LEWIS.

This is a concise treatise of the principles and methods employed in the manufacture and use of cement in all classes of modern works. The author has brought together in this work all the salient matter of interest to the user of concrete and its many diversified products. The matter is presented in logical and systematic order, clearly written, fully illustrated and free from involved mathematics. Everything of value to the concrete user is given, including kinds of cement employed in construction, concrete architecture, inspection and testing, waterproofing, coloring and painting, rules, tables, working and cost data. The book comprises thirty-three chapters, 430 pages, 126 illustrations. Price \$3.00

WATERPROOFING CONCRETE. By MYRON H. LEWIS.

Modern Methods of Waterproofing Concrete and Other Structures. A condensed statement of the Principles, Rules, and Precautions to be Observed in Waterproofing and Dampproofing Structures and Structural Materials. Price 75 cents

DICTIONARIES

STANDARD ELECTRICAL DICTIONARY. By T. O'CONNOR SLOANE.

An indispensable work to all interested in electrical science. Suitable alike for the student and professional. A practical handbook of reference containing definitions in about 5000 distinct words, terms and phrases. The definitions are terse and concise and include every term used in electrical science. Recently issued. An entirely new edition. Should be in the possession of all who desire to keep abreast with the progress of this branch of science. Complete, concise and convenient. Nearly 800 pages. Nearly 500 illustrations. New Revised and Enlarged Edition. Price \$5.00

DIES—METAL WORK

DIES: THEIR CONSTRUCTION AND USE FOR THE MODERN WORKING OF SHEET METALS. By J. V. WOODWORTH.

A most useful book, and one which should be in the hands of all engaged in the pre-working of metals; treating on the Designing, Constructing, and Use of Tools, Fixtures and Devices, together with the manner in which they should be used in the Power Press, for the cheap and rapid production of the great variety of sheet-metal articles now in use. It is designed as a guide to the production of sheet-metal parts at the minimum of cost with the maximum of output. The hardening and tempering of Press tools and the classes of work which may be produced to the best advantage by the use of dies in the power press are fully treated. Its 505 illustrations show dies, press fixtures and sheet-metal working devices, the descriptions of which are so clear and practical that all metal-working mechanics will be able to understand how to design, construct and use them. Many of the dies and press fixtures treated were either constructed by the author or under his supervision. Others were built by skilful mechanics and are in use in large sheet-metal establishments and machine shops. 6th Edition. 400 pages, 523 illustrations. Price \$3.50

PUNCHES, DIES AND TOOLS FOR MANUFACTURING IN PRESSES. By J. V. WOODWORTH.

This work is a companion volume to the author's elementary work entitled "Dies, Their Construction and Use." It does not go into the details of die-making to the extent of the author's previous book, but gives a comprehensive review of the field of operations carried on by presses. A large part of the information given has been drawn from the author's personal experience. It might well be termed an Encyclopedia of Die-Making, Punch-Making, Die-Sinking, Sheet-Metal Working, and Making of Special Tools, Sub-presses, Devices and Mechanical Combinations for Punching, Cutting, Bending, Forming, Piercing, Drawing, Compressing and Assembling Sheet-Metal Parts, and also Articles of other Materials in Machine Tools. 3rd Edition. 483 pages, 702 illustrations. Price \$4.50

CATALOGUE OF GOOD, PRACTICAL BOOKS

DRAWING—SKETCHING PAPER

PRACTICAL PERSPECTIVE. By RICHARDS and COLVIN.

Shows just how to make all kinds of mechanical drawings in the only practical perspective isometric. Makes everything plain so that any mechanic can understand a sketch or drawing in this way. Saves time in the drawing room, and mistakes in the shops. Contains practical examples of various classes of work. 4th Edition. **75 cents**

LINEAR PERSPECTIVE SELF-TAUGHT. By HERMAN T. C. KRAUS.

This work gives the theory and practice of linear perspective, as used in architectural, engineering and mechanical drawings. Persons taking up the study of the subject by themselves will be able, by the use of the instruction given, to readily grasp the subject, and by reasonable practice become good perspective draftsmen. The arrangement of the book is good; the plate is on the left-hand, while the descriptive text follows on the opposite page, so as to be readily referred to. The drawings are on sufficiently large scale to show the work clearly and are plainly figured. There is included a self-explanatory chart which gives all information necessary for the thorough understanding of perspective. This chart alone is worth many times over the price of the book. 2d Revised and enlarged Edition. **\$3.00**

SELF-TAUGHT MECHANICAL DRAWING AND ELEMENTARY MACHINE DESIGN. By F. L. SYLVESTER, M.E., Draftsman, with additions by ERIC OBERG, associate editor of "Machinery."

This is a practical treatise on Mechanical Drawing and Machine Design, comprising the first principles of geometric and mechanical drawing, workshop mathematics, mechanics, strength of materials and the calculations and design of machine details. The author's aim has been to adapt this treatise to the requirements of the practical mechanic and young draftsman and to present the matter in as clear and concise a manner as possible. To meet the demands of this class of students, practically all the important elements of machine design have been dealt with, and in addition algebraic formulas have been explained, and the elements of trigonometry treated in the manner best suited to the needs of the practical man. The book is divided into 20 chapters, and in arranging the material, mechanical drawing, pure and simple, has been taken up first, as a thorough understanding of the principles of representing objects facilitates the further study of mechanical subjects. This is followed by the mathematics necessary for the solution of the problems in machine design which are presented later, and a practical introduction to theoretical mechanics and the strength of materials. The various elements entering into machine design, such as cams, gears, sprocket-wheels, cone pulleys, bolts, screws, couplings, clutches, shafting and fly-wheels, have been treated in such a way as to make possible the use of the work as a text-book for a continuous course of study. 333 pages, 218 engravings. Price **\$2.50**

A NEW SKETCHING PAPER.

A new specially ruled paper to enable you to make sketches or drawings in isometric perspective without any figuring or fussing. It is being used for shop details as well as for assembly drawings, as it makes one sketch do the work of three, and no workman can help seeing just what is wanted. Pads of 40 sheets, 6x9 inches, **40 cents**. Pads of 40 sheets, 9x12 inches, **75 cents**; 40 sheets, 12x18, Price **\$1.50**

ELECTRICITY

ARITHMETIC OF ELECTRICITY. By Prof. T. O'CONNOR SLOANE.

A practical treatise on electrical calculations of all kinds reduced to a series of rules, all of the simplest forms, and involving only ordinary arithmetic; each rule illustrated by one or more practical problems, with detailed solution of each one. This book is classed among the most useful works published on the science of electricity, covering as it does the mathematics of electricity in a manner that will attract the attention of those who are not familiar with algebraical formulas. 22nd Edition. 196 pages. Price **\$1.50**

CATALOGUE OF GOOD, PRACTICAL BOOKS

COMMUTATOR CONSTRUCTION. By WM. BAXTER, JR.

The business end of any dynamo or motor of the direct current type is the commutator. This book goes into the designing, building, and maintenance of commutators, shows how to locate troubles and how to remedy them; everyone who fusses with dynamos needs this. 5th Edition 35 cents

CONSTRUCTION OF A TRANSATLANTIC WIRELESS RECEIVING SET. By L. G. PACENT and T. S. CURTIS.

A work for the Radio student who desires to construct and operate apparatus that will permit of the reception of messages from the large stations in Europe with an aerial of amateur proportions. 36 pages. 23 illustrations, cloth. Price . 35 cents

DYNAMO BUILDING FOR AMATEURS, OR HOW TO CONSTRUCT A FIFTY-WATT DYNAMO. By ARTHUR J. WEED, Member of N. Y. Electrical Society.

A practical treatise showing in detail the construction of a small dynamo or motor, the entire machine work of which can be done on a small foot lathe. Dimensioned working drawings are given for each piece of machine work, and each operation is clearly described. This machine, when used as a dynamo, has an output of fifty watts; when used as a motor it will drive a small drill press or lathe. It can be used to drive a sewing machine on any and all ordinary work. The book is illustrated with more than sixty original engravings showing the actual construction of the different parts. Among the contents are chapters on: 1. Fifty-Watt Dynamo. 2. Side Bearing Rods. 3. Field Punching. 4. Bearings. 5. Commutator. 6. Pulley. 7. Brush Holders. 8. Connection Board. 9. Armature Shaft. 10. Armature. 11. Armature Winding. 12. Field Winding. 13. Connecting and Starting. Price, cloth, \$1.00

DESIGN DATA FOR RADIO TRANSMITTERS AND RECEIVERS. By MILTON B. SLEEPER.

Far from being a collection of formulas, Design Data takes up in proper sequence the problems encountered in planning all types of receiving sets for short, medium and long wave work, and spark coil, transformer and vacuum tube transmitters operating on 200 meters. Tables have been worked out so that values can be found without the use of mathematics. Radio experimenters will find here information which will enable them to have the most modern and efficient equipment. Price . . . 75 cents

DYNAMOS AND ELECTRIC MOTORS AND ALL ABOUT THEM. By EDWARD TREVERT.

This volume gives practical directions for building a two H. P. Dynamo of the Edison type capable of lighting about fifty Mazda lamps of the 20-watt size. In addition, it gives directions for building two small electric motors suitable for running sewing machines. The concluding chapter describes the construction of a simple bichromate battery adapted for running electric motors. 96 pages. Fully illustrated with detail drawings. Cloth. Price \$1.00

ELECTRIC BELLS. By M. B. SLEEPER.

A complete treatise for the practical worker in installing, operating, and testing bell circuits, burglar alarms, thermostats, and other apparatus used with electric bells. Both the electrician and the experimenter will find in this book new material which is essential in their work. Tools, bells, batteries, unusual circuits, burglar alarms, annunciators, systems, thermostats, circuit breakers, time alarms, and other apparatus used in bell circuits are described from the standpoints of their application, construction, and repair. The detailed instructions for building the apparatus will appeal to the experimenter particularly. The practical worker will find the chapters on Wiring Calculation of Wire Sizes and Magnet Windings, Upkeep of Systems and the Location of Faults of the greatest value in their work. 124 pages. Fully illustrated. Price 75 cents

CATALOGUE OF GOOD, PRACTICAL BOOKS

EXPERIMENTAL HIGH FREQUENCY APPARATUS — HOW TO MAKE AND USE IT. By THOMAS STANLEY CURTIS.

This book tells you how to build simple high frequency coils for experimental purpose in the home, school laboratory, or on the small lecture platform. The book is really a supplement to the same author's "High Frequency Apparatus." The experimental side only is covered in this volume, which is intended for those who want to build small coils giving up to an eighteen-inch spark. The book contains valuable information for the physics or the manual training teacher who is on the lookout for interesting projects for his boys to build or experiment with. The apparatus is simple, cheap and perfectly safe, and with it some truly startling experiments may be performed. Among the contents are: Induction Coil Outfits Operated on Battery Current. Kicking Coil Apparatus. One-Half Kilowatt Transformer Outfit. Parts and Materials, etc., etc. 69 pages. Illustrated. Price 50 cents

HIGH FREQUENCY APPARATUS, ITS CONSTRUCTION AND PRACTICAL APPLICATION. By THOMAS STANLEY CURTIS.

The most comprehensive and thorough work on this interesting subject ever produced. The book is essentially practical in its treatment and it constitutes an accurate record of the researches of its author over a period of several years, during which time dozens of coils were built and experimented with. The work has been divided into six basic parts. The first two chapters tell the uninitiated reader what the high frequency current is, what it is used for, and how it is produced. The second section, comprising four chapters, describes in detail the principles of the transformer, condenser, spark gap, and oscillation transformer, and covers the main points in the design and construction of these devices as applied to the work in hand. The third section covers the construction of small high frequency outfits designed for experimental work in the home laboratory or in the classroom. The fourth section is devoted to electro-therapeutic and X-Ray apparatus. The fifth describes apparatus for the cultivation of plants and vegetables. The sixth section is devoted to a comprehensive discussion of apparatus of large size for use upon the stage in spectacular productions. The closing chapter, giving the current prices of the parts and materials required for the construction of the apparatus described, is included with a view to expediting the purchase of the necessary goods. The Second Edition includes much new matter along the line of home-made therapeutic outfits for physicians' use. The matter on electro plant culture has also been elaborated upon. Second Revised and Enlarged Edition. 266 pages. New second edition. Fully illustrated. Price . \$3.00

ELECTRIC WIRING, DIAGRAMS AND SWITCHBOARDS. By NEWTON HARRISON.

A thoroughly practical treatise covering the subject of Electric Wiring in all its branches, including explanations and diagrams which are thoroughly explicit and greatly simplify the subject. Practical, every-day problems in wiring are presented and the method of obtaining intelligent results clearly shown. Only arithmetic is used. Ohm's law is given a simple explanation with reference to wiring for direct and alternating currents. The fundamental principle of drop of potential in circuits is shown with its various applications. The simple circuit is developed with the position of mains, feeders and branches; their treatment as a part of a wiring plan and their employment in house wiring clearly illustrated. Some simple facts about testing are included in connection with the wiring. Molding and conduit work are given careful consideration; and switchboards are systematically treated, built up and illustrated, showing the purpose they serve, for connection with the circuits, and to shunt and compound wound machines. The simple principles of switchboard construction, the development of the switchboard, the connections of the various instruments, including the lightning arrester, are also plainly set forth.

Alternating current wiring is treated, with explanations of the power factor, conditions calling for various sizes of wire, and a simple way of obtaining the sizes for single-phase, two-phase and three-phase circuits. This is the only complete work issued showing and telling you what you should know about direct and alternating current wiring. It is a ready reference. The work is free from advanced technicalities and mathematics, arithmetic being used throughout. It is in every respect a handy, well-written, instructive, comprehensive volume on wiring for the wireman, foreman, contractor, or electrician. 3rd edition, revised and enlarged. 315 pages; 137 illustrations. Price \$2.50

CATALOGUE OF GOOD, PRACTICAL BOOKS

ELECTRIC TOY MAKING, DYNAMO BUILDING, AND ELECTRIC MOTOR CONSTRUCTION. By Prof. T. O'CONOR SLOANE.

This work treats of the making at home of electrical toys, electrical apparatus, motors, dynamos and instruments in general, and is designed to bring within the reach of young and old the manufacture of genuine and useful electrical appliances. The work is especially designed for amateurs and young folks.

Thousands of our young people are daily experimenting, and busily engaged in making electrical toys and apparatus of various kinds. The present work is just what is wanted to give the much needed information in a plain, practical manner, with illustrations to make easy the carrying out of the work. 20th Edition. 210 pages, 77 illustrations. Price \$1.50

ELECTRICIANS' HANDY BOOK. By Prof. T. O'CONOR SLOANE.

This work is intended for the practical electrician who has to make things go. The entire field of electricity is covered within its pages. Among some of the subjects treated are: The Theory of the Electric Current and Circuit, Electro-Chemistry, Primary Batteries, Storage Batteries, Generation and Utilization of Electric Powers, Alternating Current, Armature Winding, Dynamos and Motors, Motor Generators, Operation of the Central Station Switchboards, Safety Appliances, Distribution of Electric Light and Power, Street Mains, Transformers, Arc and Incandescent Lighting, Electric Measurements, Photometry, Electric Railways, Telephony, Bell-Wiring, Electric-Plating, Electric Heating, Wireless Telegraphy, etc. It contains no useless theory; everything is to the point. It teaches you just what you want to know about electricity. It is the standard work published on the subject. Forty-six chapters, 600 engravings. New 5th Edition, Revised and Enlarged. Price \$4.00

ELECTRICITY SIMPLIFIED. By Prof. T. O'CONOR SLOANE.

The object of "Electricity Simplified" is to make the subject as plain as possible and to show what the modern conception of electricity is; to show how two plates of different metal, immersed in acid, can send a message around the globe; to explain how a bundle of copper wire rotated by a steam engine can be the agent in lighting our streets, to tell what the volt, ohm and ampere are, and what high and low tension mean; and to answer the questions that perpetually arise in the mind in this age of electricity. 15th Revised Edition. 218 pages. Illustrated. Price . . \$1.50

EXPERIMENTAL WIRELESS STATIONS. By P. E. EDELMAN.

The theory, design, construction and operation is fully treated including Wireless Telephony, Vacuum Tube, and quenched spark systems. The new enlarged edition is just issued and is strictly up to date, correct and complete. This book tells how to make apparatus to not only hear all telephoned and telegraphed radio messages, but also how to make simple equipment that works for transmission over reasonably long distances. Then there is a host of new information included. The first and only book to give you all the recent important radio improvements, some of which have never before been published. This volume anticipates every need of the reader who wants the gist of the art, its principles, simplified calculations, apparatus dimensions, and understandable directions for efficient operation.

Vacuum tube circuits; amplifiers; long-distance sets; loop, coil, and underground receivers; tables of wave-lengths, capacity, inductance; such are a few of the subjects presented in detail that satisfies. It is independent and one of the few that describe *all* modern systems.

Endorsed by foremost instructors for its clear accuracy, preferred by leading amateurs for its dependable designs. The new experimental Wireless Stations is sure to be most satisfactory for your purposes. 27 chapters, 392 pages. 167 illustrations. Price \$3.00

RADIO TIME SIGNAL RECEIVER. By AUSTIN C. LESCARBOURA.

This new book, "A Radio Time Signal Receiver," tells you how to build a simple outfit designed expressly for the beginner. You can build the outfits in your own workshop and install them for jewelers either on a one-payment or a rental basis. The apparatus is of such simple design that it may be made by the average amateur mechanic possessing a few ordinary tools. 42 pages. Paper. Price . . 35 cents

CATALOGUE OF GOOD, PRACTICAL BOOKS

HOUSE WIRING. By THOMAS W. POPPE.

This work describes and illustrates the actual installation of Electric Light Wiring, the manner in which the work should be done, and the method of doing it. The book can be conveniently carried in the pocket. It is intended for the Electrician, Helps, and Apprentice. It solves all Wiring Problems and contains nothing that conflicts with the rulings of the National Board of Fire Underwriters. It gives just the information essential to the Successful Wiring of a Building. Among the subjects treated are Locating the Meter. Panel Boards. Switches. Plug Receptacles. Brackets. Ceiling Fixtures. The Meter Connections. The Feed Wires. The Steel Armored Cable System. The Flexible Steel Conduit System. The Rigid Conduit System. A digest of the National Board of Fire Underwriters' rules relating to metallic wiring systems. Various switching arrangements explained and diagrammed. The easiest method or testing the Three- and Four-way circuits explained. The grounding of all metallic wiring systems and the reason for doing so shown and explained. The insulation of the metal parts of lamp fixtures and the reason for the same described and illustrated. 208 pages. 4th Edition, revised and enlarged. 160 illustrations. Flexible cloth. Price \$1.00

HOW TO BECOME A SUCCESSFUL ELECTRICIAN. By Prof. T. O'CONNOR SLOANE.

Every young man who wishes to become a successful electrician should read this book. It tells in simple language the surest and easiest way to become a successful electrician. The studies to be followed, methods of work, field of operation and the requirement, of the successful electrician are pointed out and fully explained. Every young engineer will find this an excellent stepping stone to more advanced works on electricity which he must master before success can be attained. Many young men become discouraged at the very outstart by attempting to read and study books that are far beyond their comprehension. This book serves as the connecting link between the rudiments taught in the public schools and the real study of electricity. It is interesting from cover to cover. 19th Revised Edition, just issued. 205 pages. Illustrated. Price \$1.50

RADIO HOOK-UPS. By MILTON B. SLEEPER.

In this book the best circuits for different instruments and various purposes have been carefully selected and grouped together. All the best circuits for damped and undamped wave receiving sets, buzzer, spark coil and transformer sending equipment, as well as vacuum tube telegraph and telephone transmitters, wavemeters, vacuum tube measuring instruments, audibility meters, etc., are shown in this book. . 75 cents

STANDARD ELECTRICAL DICTIONARY. By T. O'CONNOR SLOANE.

An indispensable work to all interested in electrical science. Suitable alike for the student and professional. A practical handbook of reference containing definitions of about 5,000 distinct words, terms and phrases. The definitions are terse and concise and include every term used in electrical science. Recently issued. An entirely new edition. Should be in the possession of all who desire to keep abreast with the progress of this branch of science. In its arrangement and typography the book is very convenient. The word or term defined is printed in black-faced type which readily catches the eye, while the body of the page is in smaller but distinct type. The definitions are well worded, and so as to be understood by the non-technical reader. The general plan seems to be to give an exact, concise definition, and then amplify and explain in a more popular way. Synonyms are also given, and references to other words and phrases are made. A very complete and accurate index of fifty pages is at the end of the volume; and as this index contains all synonyms, and as all phrases are indexed in every reasonable combination of words, reference to the proper place in the body of the book is readily made. It is difficult to decide how far a book of this character is to keep the dictionary form, and to what extent it may assume the encyclopedia form. For some purposes, concise, exactly worded definitions are needed; for other purposes, more extended descriptions are required. This book seeks to satisfy both demands, and does it with considerable success. Complete, concise and convenient. 800 pages. Nearly 500 illustrations. New Revised and Enlarged Edition. Price \$5.00

CATALOGUE OF GOOD, PRACTICAL BOOKS

STORAGE BATTERIES SIMPLIFIED. BY VICTOR W. PAGÉ, M.S.A.E.

A complete treatise on storage battery operating principles, repairs and applications. The greatly increasing application of storage batteries in modern engineering and mechanical work has created a demand for a book that will consider this subject completely and exclusively. This is the most thorough and authoritative treatise ever published on this subject. It is written in easily understandable, non-technical language so that anyone may grasp the basic principles of storage battery action as well as their practical industrial applications. All electric and gasoline automobiles use storage batteries. Every automobile repairman, dealer or salesman should have a good knowledge of maintenance and repair of these important elements of the motor car mechanism. This book not only tells how to charge, care for and rebuild storage batteries but also outlines all the industrial uses. Learn how they run street cars, locomotives and factory trucks. Get an understanding of the important functions they perform in submarine boats, isolated lighting plants, railway switch and signal systems, marine applications, etc. This book tells how they are used in central station standby service, for starting automobile motors and in ignition systems. Every practical use of the modern storage battery is outlined in this treatise. 208 pages. Fully illustrated. Price \$2.00

TELEPHONE CONSTRUCTION, INSTALLATION, WIRING, OPERATION AND MAINTENANCE. BY W. H. RADCLIFFE and H. C. CUSHING.

This book is intended for the amateur, the wireman, or the engineer who desires to establish a means of telephonic communication between the rooms of his home, office, or shop. It deals only with such things as may be of use to him rather than with theories.

Gives the principles of construction and operation of both the Bell and Independent instruments; approved methods of installing and wiring them; the means of protecting them from lightning and abnormal currents; their connection together for operation as series or bridging stations; and rules for their inspection and maintenance. Line wiring and the wiring and operation of special telephone systems are also treated.

Intricate mathematics are avoided, and all apparatus, circuits and systems are thoroughly described. The appendix contains definitions of units and terms used in the text. Selected wiring tables, which are very helpful, are also included. Among the subjects treated are Construction, Operation, and Installation of Telephone Instruments; Inspection and Maintenance of Telephone Instruments; Telephone Line Wiring; Testing Telephone Line Wires and Cables; Wiring and Operation of Special Telephone Systems, etc. 2nd Edition, revised and enlarged. 223 pages. 154 illustrations \$1.50

WIRELESS TELEGRAPHY AND TELEPHONY SIMPLY EXPLAINED. BY ALFRED P. MORGAN.

This is undoubtedly one of the most complete and comprehensible treatises on the subject ever published, and a close study of its pages will enable one to master all the details of the wireless transmission of messages. The author has filled a long-felt want and has succeeded in furnishing a lucid, comprehensible explanation in simple language of the theory and practice of wireless telegraphy and telephony.

Among the contents are: Introductory; Wireless Transmission and Reception—The Aerial System, Earth Connections—The Transmitting Apparatus, Spark Coils and Transformers, Condensers, Helices, Spark Gaps, Anchor Gaps, Aerial Switches—The Receiving Apparatus, Detectors, etc.—Tuning and Coupling, Tuning Coils, Loose Couplers, Variable Condensers, Directive Wave Systems—Miscellaneous Apparatus, Telephone Receivers, Range of Stations, Static Interference—Wireless Telephones, Sound and Sound Waves, The Vocal Cords and Ear—Wireless Telephone, How Sounds Are Changed into Electric Waves—Wireless Telephones, The Apparatus—Summary. 154 pages. 156 engravings. Price \$1.50

WIRING A HOUSE. BY HERBERT PRATT.

Shows a house already built; tells just how to start about wiring it; where to begin; what wire to use; how to run it according to Insurance Rules; in fact, just the information you need. Directions apply equally to a shop. Fourth edition . . . 35 cents

ELECTROPLATING

THE MODERN ELECTROPLATER. By KENNETH M. COGGESHALL.

This is one of the most complete and practical books on electroplating and allied processes that has been published as a text for the student or professional plater. It is written in simple language and explains all details of electroplating in a concise yet complete manner. It starts at the beginning and gives an elementary outline of electricity and chemistry as relates to plating, then considers shop layout and equipment and gives all the necessary information to do reliable and profitable electroplating in a modern commercial manner. Full instructions are given for the preparation and finishing of the work and formulae and complete directions are included for making all kinds of plating solutions, many of these having been trade secrets until published in this instruction manual. Anyone interested in practical plating and metal finishing will find this book a valuable guide and complete manual of the art. Cloth. 142 illustrations. 276 pages. Price \$3.00

FACTORY MANAGEMENT, ETC.

MODERN MACHINE SHOP CONSTRUCTION, EQUIPMENT AND MANAGEMENT. By O. E. PERRIGO, M.E.

The only work published that describes the modern machine shop or manufacturing plant from the time the grass is growing on the site intended for it until the finished product is shipped. By a careful study of its thirty-six chapters the practical man may economically build, efficiently equip, and successfully manage the modern machine shop or manufacturing establishment. Just the book needed by those contemplating the erection of modern shop buildings, the rebuilding and reorganization of old ones, or the introduction of modern shop methods, time and cost systems. It is a book written and illustrated by a practical shop man for practical shop men who are too busy to read theories and want facts. It is the most complete all-around book of its kind ever published. It is a practical book for practical men, from the apprentice in the shop to the president in the office. It minutely describes and illustrates the most simple and yet the most efficient time and cost system yet devised. 384 pages. 219 illustrations. Price \$5.00

FUEL

COMBUSTION OF COAL AND THE PREVENTION OF SMOKE. By Wm. M. BARR.

This book has been prepared with special reference to the generation of heat by the combustion of the common fuels found in the United States, and deals particularly with the conditions necessary to the economic and smokeless combustion of bituminous coals in Stationary and Locomotive Steam Boilers.

The presentation of this important subject is systematic and progressive. The arrangement of the book is in a series of practical questions to which are appended accurate answers, which describe in language, free from technicalities, the several processes involved in the furnace combustion of American fuels; it clearly states the essential requisites for perfect combustion, and points out the best methods for furnace construction for obtaining the greatest quantity of heat from any given quality of coal. 5th Edition. Nearly 350 pages, fully illustrated. Price. . . . \$1.50

CATALOGUE OF GOOD, PRACTICAL BOOKS

GAS AND OIL ENGINES

THE GASOLINE ENGINE ON THE FARM: ITS OPERATION, REPAIR AND USES. By XENO W. PUTNAM.

This is a practical treatise on the Gasoline and Kerosene Engine intended for the man who wants to know just how to manage his engine and how to apply it to all kinds of farm work to the best advantage.

This book abounds with hints and helps for the farm and suggestions for the home and housewife. There is so much of value in this book that it is impossible to adequately describe it in such small space. Suffice to say that it is the kind of a book every farmer will appreciate and every farm home ought to have. Includes selecting the most suitable engine for farm work, its most convenient and efficient installation, with chapters on troubles, their remedies, and how to avoid them. The care and management of the farm tractor in plowing, harrowing, harvesting and road grading are fully covered; also plain directions are given for handling the tractor on the road. Special attention is given to relieving farm life of its drudgery by applying power to the disagreeable small tasks which must otherwise be done by hand. Many home-made contrivances for cutting wood, supplying kitchen, garden, and barn with water, loading, hauling and unloading hay, delivering grain to the bins or the feed trough are included; also full directions for making the engine milk the cows, churn, wash, sweep the house and clean the windows, etc. Very fully illustrated with drawings of working parts and cuts showing Stationary, Portable and Tractor Engines doing all kinds of farm work. All money-making farms utilize power. Learn how to utilize power by reading the pages of this book. It is an aid to the result getter, invaluable to the up-to-date farmer, student, blacksmith, implement dealer and, in fact, all who can apply practical knowledge of stationary gasoline engines or gas tractors to advantage. 530 pages. Nearly 180 engravings. Price \$3.00

GASOLINE ENGINES: THEIR OPERATION, USE AND CARE. By A. HATT VERRILL.

The simplest, latest and most comprehensive popular work published on Gasoline Engines, describing what the Gasoline Engine is; its construction and operation; how to install it; how to select it; how to use it and how to remedy troubles encountered. Intended for Owners, Operators and Users of Gasoline Motors of all kinds. This work fully describes and illustrates the various types of Gasoline Engines used in Motor Boats, Motor Vehicles and Stationary Work. The parts, accessories and appliances are described, with chapters on ignition, fuel, lubrication, operation and engine troubles. Special attention is given to the care, operation and repair of motors, with useful hints and suggestions on emergency repairs and makeshifts. A complete glossary of technical terms and an alphabetically arranged table of troubles and their symptoms form most valuable and unique features of this manual. Nearly every illustration in the book is original, having been made by the author. Every page is full of interest and value. A book which you cannot afford to be without. 275 pages. 152 specially made engravings. Price \$2.00

GAS, GASOLINE, AND OIL ENGINES. By GARDNER D. HISCOX.

Just issued, 23d revised and enlarged edition. Every user of a gas engine needs this book. Simple, instructive, and right up-to-date. The only complete work on the subject. Tells all about the running and management of gas, gasoline and oil engines, as designed and manufactured in the United States. Explosive motors for stationary marine and vehicle power are fully treated, together with illustrations of their parts and tabulated sizes, also their care and running are included. Electric ignition by induction coil and jump spark are fully explained and illustrated, including valuable information on the testing for economy and power and the erection of power plants.

The rules and regulations of the Board of Fire Underwriters in regard to the installation and management of gasoline motors are given in full, suggesting the safe installation of explosive motor power. A list of United States Patents issued on gas, gasoline, and oil engines and their adjuncts from 1875 to date is included. 640 pages. 435 engravings. Folding plates. Price \$3.00

CATALOGUE OF GOOD, PRACTICAL BOOKS

GAS ENGINES AND PRODUCER-GAS PLANTS. By R. E. MATHOT, M.E.

This is a practical treatise, setting forth the principles of gas engine and producer design, the selection and installation of an engine, conditions of perfect operation, producer-gas engines and their possibilities; the care of gas engines and producer-gas plants, with a chapter on volatile hydrocarbon and oil engines. A practical guide for the gas engine designer, user and engineer in the construction, selection, purchase, installation, operation and maintenance of gas engines. *Every part of the gas engine is described in detail, tersely, clearly and with a thorough understanding of the requirements of the mechanic.* Recognizing the need of a volume that would assist the gas engine user in understanding the motor upon which he depends for power, the author has discussed the subject without the help of any mathematics. Helpful suggestions as to the purchase of an engine, its installation, care and operation, form a most valuable feature of the book. 6 x 9 inches. Cloth. 314 pages. 152 illustrations. Price. **\$3.00**

GAS ENGINE CONSTRUCTION, OR HOW TO BUILD A HALF-HORSE-POWER GAS ENGINE. By PARSELL and WEED.

A practical treatise of 300 pages describing the theory and principles of the action of Gas Engines of various types and the design and construction of a half-horse-power Gas Engine, with illustrations of the work in actual progress, together with the dimensioned working drawings, giving clearly the sizes of the various details; for the student, the scientific investigator, and the amateur mechanic. This book treats of the subject more from the standpoint of practice than that of theory. The principles of operation of Gas Engines are clearly and simply described, and then the actual construction of a half-horse-power engine is taken up, step by step, showing in detail the making of the Gas Engine. 3d Edition. 300 pages. Price **\$3.00**

HOW TO RUN AND INSTALL GASOLINE ENGINES. By C. VON CULIN.

Revised and enlarged edition just issued. The object of this little book is to furnish a pocket instructor for the beginner, the busy man who uses an engine for pleasure or profit, but who does not have the time or inclination for a technical book, but simply to thoroughly understand how to properly operate, install and care for his own engine. The index refers to each trouble, remedy, and subject alphabetically. Being a quick reference to find the cause, remedy and prevention for troubles, and to become an expert with his own engine. Pocket size. Paper binding. Price **25 cents**

GEARING AND CAMS

BEVEL GEAR TABLES. By D. AG. ENGSTROM.

A book that will at once commend itself to mechanics and draftsmen. Does away with all the trigonometry and fancy figuring on bevel gears, and makes it easy for anyone to lay them out or make them just right. There are 36 full-page tables that show every necessary dimension for all sizes or combinations you're apt to need. No puzzling, figuring or guessing. Gives placing distance, all the angles (including cutting angles), and the correct cutter to use. A copy of this prepares you for anything in the bevel-gear line. 3d Edition. 66 pages. **\$1.50**

CHANGE GEAR DEVICES. By OSCAR E. PERRIGO.

A practical book for every designer, draftsman, and mechanic interested in the invention and development of the devices for feed changes on the different machines requiring such mechanism. All the necessary information on this subject is taken up, analyzed, classified, sifted, and concentrated for the use of busy men who have not the time to go through the masses of irrelevant matter with which such a subject is usually encumbered and select such information as will be useful to them.

It shows just what has been done, how it has been done, when it was done, and who did it. It saves time in hunting up patent records and re-inventing old ideas. 3rd Edition. 101 pages **\$1.50**

DRAFTING OF CAMS. By LOUIS ROUILLION.

The laying out of cams is a serious problem unless you know how to go at it right. This puts you on the right road for practically any kind of cam you are likely to run up against. 3d Edition. **35 cents**

CATALOGUE OF GOOD, PRACTICAL BOOKS

HYDRAULICS

HYDRAULIC ENGINEERING. By GARDNER D. HISCOX.

A treatise on the properties, power, and resources of water for all purposes. Including the measurement of streams, the flow of water in pipes or conduits; the horse-power of falling water, turbine and impact water-wheels, wave motors, centrifugal, reciprocating and air-lift pumps. With 300 figures and diagrams and 36 practical tables. All who are interested in water-works development will find this book a useful one, because it is an entirely practical treatise upon a subject of present importance, and cannot fail in having a far-reaching influence, and for this reason should have a place in the working library of every engineer. Among the subjects treated are: Historical Hydraulics, Properties of Water, Measurement of the Flow of Streams; Flowing Water Surface Orifices and Nozzles; Flow of Water in Pipes; Siphons of Various Kinds; Dams and Great Storage Reservoirs; City and Town Water Supply; Wells and Their Reinforcement; Air Lift Methods of Raising Water; Artesian Wells, Irrigation of Arid Districts; Water Power; Water-Wheels; Pumps and Pumping Machinery; Reciprocating Pumps; Hydraulic Power Transmission; Hydraulic Mining; Canals; Dredges; Conduits and Pipe Lines; Marine Hydraulics; Tidal and Sea Wave Power, etc. 320 pages. Price \$4.50

ICE AND REFRIGERATION

POCKETBOOK OF REFRIGERATION AND ICE MAKING. By A. J. WALLIS-TAYLOR.

This is one of the latest and most comprehensive reference books published on the subject of refrigeration and cold storage. It explains the properties and refrigerating effect of the different fluids in use, the management of refrigerating machinery and the construction and insulation of cold rooms with their required pipe surface for different degrees of cold; freezing mixtures and non-freezing brines, temperatures of cold rooms for all kinds of provisions, cold storage charges for all classes of goods, ice making and storage of ice, data and memoranda for constant reference by refrigerating engineers. With nearly one hundred tables containing valuable references to every fact and condition required in the installment and operation of a refrigerating plant. New edition just published. Price \$2.00

INVENTIONS—PATENTS

INVENTORS' MANUAL, HOW TO MAKE A PATENT PAY.

This is a book designed as a guide to inventors in perfecting their inventions, taking out their patents and disposing of them. It is not in any sense a Patent Solicitor's Circular nor a Patent Broker's Advertisement. No advertisements of any description appear in the work. It is a book containing a quarter of a century's experience of a successful inventor, together with notes based upon the experience of many other inventors.

Among the subjects treated in this work are: How to Invent. How to Secure a Good Patent. Value of Good Invention. How to Exhibit an Invention. How to Interest Capital. How to Estimate the Value of a Patent. Value of Design Patents. Value of Foreign Patents. Value of Small Inventions. Advice on Selling Patents. Advice on the Formation of Stock Companies. Advice on the Formation of Limited Liability Companies. Advice on Disposing of Old Patents. Advice as to Patent Attorneys. Advice as to Selling Agents. Forms of Assignments. License and Contracts. State Laws Concerning Patent Rights. 1900 Census of the United States by Counts of Over 10,000 Population. New revised and enlarged edition. 144 pages. Illustrated. Price \$1.50

CATALOGUE OF GOOD, PRACTICAL BOOKS

KNOTS

KNOTS, SPLICES AND ROPE WORK. By A. HYATT VERRILL.

This is a practical book giving complete and simple directions for making all the most useful and ornamental knots in common use, with chapters on Splicing, Pointing, Seizing, Serving, etc. This book is fully illustrated with one hundred and fifty original engravings, which show how each knot, tie or splice is formed, and its appearance when finished. The book will be found of the greatest value to Campers, Yachtsmen, Travelers, Boy Scouts, in fact, to anyone having occasion to use or handle rope or knots for any purpose. The book is thoroughly reliable and practical, and is not only a guide, but a teacher. It is the standard work on the subject. Among the contents are: 1. Cordage, Kinds of Rope. Construction of Rope, Parts of Rope Cable and Bolt Rope. Strength of Rope, Weight of Rope. 2. Simple Knots and Bends. Terms Used in Handling Rope. Seizing Rope. 3. Ties and Hitches. 4. Noose, Loops and Mooring Knots. 5. Shortenings, Grommets and Salvages. 6. Lashings, Seizings and Splices. 7. Fancy Knots and Rope Work. 104 pages. 154 original engravings. Price \$1.00

LATHE WORK

LATHE DESIGN, CONSTRUCTION, AND OPERATION, WITH PRACTICAL EXAMPLES OF LATHE WORK. By OSCAR E. PERRIGO.

A new revised edition, and the only complete American work on the subject, written by a man who knows not only how work ought to be done, but who also knows how to do it, and how to convey this knowledge to others. It is strictly up-to-date in its descriptions and illustrations. Lathe history and the relations of the lathe to manufacturing are given; also a description of the various devices for feeds and thread cutting mechanisms from early efforts in this direction to the present time. Lathe design is thoroughly discussed, including back gearing, driving cones, thread-cutting gears, and all the essential elements of the modern lathe. The classification of lathes is taken up, giving the essential differences of the several types of lathes including, as is usually understood, engine lathes, bench lathes, speed lathes, forge lathes, gap lathes, pulley lathes, forming lathes, multiple-spindle lathes, rapid-reduction lathes, precision lathes, turret lathes, special lathes, electrically-driven lathes, etc. In addition to the complete exposition on construction and design, much practical matter on lathe installation, care and operation has been incorporated in the enlarged 1915 edition. All kinds of lathe attachments for drilling, milling, etc., are described and complete instructions are given to enable the novice machinist to grasp the art of lathe operation as well as the principles involved in design. A number of difficult machining operations are described at length and illustrated. The new edition has nearly 500 pages and 350 illustrations. Price \$3.00

LATHE WORK FOR BEGINNERS. By RAYMOND FRANCIS YATES.

A simple, straightforward text-book for those desiring to learn the operation of a wood-turning or metal-turning lathe. The first chapter tells how to choose a lathe and all of the standard types on the market are described. Simple and more advanced lathe work is thoroughly covered and the operation of all lathe attachments such as millers, grinders, polishers, etc., is described. The treatment starts from the very bottom and leads the reader through to a point where he will be able to handle the larger commercial machines with very little instruction. The last chapter of the book is devoted to things to make on the lathe and includes a model rapid-fire naval gun. This is the only book published in this country that treats lathe work from the standpoint of the amateur mechanic. 162 illustrations. About 250 pages, 12mo. Price \$2.00

TURNING AND BORING TAPERS. By FRED H. COLVIN.

There are two ways to turn tapers; the right way and one other. This treatise has to do with the right way; it tells you how to start the work properly, how to set the lathe, what tools to use and how to use them, and forty and one other little things that you should know. Fifth edition. Price 35 cents

LIQUID AIR

LIQUID AIR AND THE LIQUEFACTION OF GASES. By T. O'CONNOR SLOANE.

This book gives the history of the theory, discovery, and manufacture of Liquid Air, and contains an illustrated description of all the experiments that have excited the wonder of audiences all over the country. It shows how liquid air, like water, is carried hundreds of miles and is handled in open buckets. It tells what may be expected from it in the near future.

A book that renders simple one of the most perplexing chemical problems of the century. Startling developments illustrated by actual experiments.

It is not only a work of scientific interest and authority, but is intended for the general reader, being written in a popular style—easily understood by everyone. Third edition. Revised and Enlarged. 394 pages. New Edition. Price . . . \$3.00

LOCOMOTIVE ENGINEERING

AIR-BRAKE CATECHISM. By ROBERT H. BLACKALL.

This book is a standard text-book. It covers the Westinghouse Air-Brake Equipment, including the No. 5 and the No. 6 E. T. Locomotive Brake Equipment; the K (Quick Service) Triple Valve for Freight Service; and the Cross-Compound Pump. The operation of all parts of the apparatus is explained in detail, and a practical way of finding their peculiarities and defects, with a proper remedy, is given. It contains 2,000 questions with their answers, which will enable any railroad man to pass any examination on the subject of Air Brakes. Endorsed and used by air-brake instructors and examiners on nearly every railroad in the United States. 28th Edition. 411 pages, fully illustrated with colored plates and diagrams. Price \$2.50

COMBUSTION OF COAL AND THE PREVENTION OF SMOKE. By Wm. M. BARR.

This book has been prepared with special reference to the generation of heat by the combustion of the common fuels found in the United States and deals particularly with the conditions necessary to the economic and smokeless combustion of bituminous coal in Stationary and Locomotive Steam Boilers.

Presentation of this important subject is systematic and progressive. The arrangement of the book is in a series of practical questions to which are appended accurate answers, which describe in language free from technicalities the several processes involved in the furnace combustion of American fuels; it clearly states the essential requisites for perfect combustion, and points out the best methods of furnace construction for obtaining the greatest quantity of heat from any given quality of coal. Nearly 350 pages, fully illustrated. Price \$1.50

DIARY OF A ROUND-HOUSE FOREMAN. By T. S. REILLY.

This is the greatest book of railroad experiences ever published. Containing a fund of information and suggestions along the line of handling men, organizing, etc., that one cannot afford to miss. 158 pages. Price \$1.50

LINK MOTIONS, VALVES AND VALVE SETTING. By FRED H. COLVIN,
Associate Editor of *American Machinist*.

A handy book for the engineer or machinist that clears up the mysteries of valve setting. Shows the different valve gears in use, how they work, and why. Piston and slide valves of different types are illustrated and explained. A book that every railroad man in the motive power department ought to have. Contains chapters on Locomotive Link Motion, Valve Movements, Setting Slide Valves, Analysis by Diagrams, Modern Practice, Slip of Block, Slice Valves, Piston Valves, Setting Piston Valves, Joy-Allen Valve Gear, Walschaert Valve Gear, Gooch Valve Gear, Alfree-Hubbell Valve Gear, etc., etc. 3rd Edition, 101 pages. Fully illustrated. Price
75 cents

CATALOGUE OF GOOD, PRACTICAL BOOKS

LOCOMOTIVE BOILER CONSTRUCTION. By FRANK A. KLEINHANS.

The construction of boilers in general is treated, and, following this, the locomotive boiler is taken up in the order in which its various parts go through the shop. Shows all types of boilers used; gives details of construction; practical facts, such as life of riveting, punches and dies; work done per day, allowance for bending and flanging sheets, and other data. Including the recent Locomotive Boiler Inspection Laws and Examination Questions with their answers for Government Inspectors. Contains chapters on Laying Out Work; Flanging and Forging; Punching; Shearing; Plate Planing; General Tables; Finishing Parts; Bending; Machinery Parts; Riveting; Boiler Details; Smoke Box Details; Assembling and Calking; Boiler Shop Machinery, etc., etc.

There isn't a man who has anything to do with boiler work, either new or repair work, who doesn't need this book. The manufacturer, superintendent, foreman, and boiler worker—all need it. No matter what the type of boiler, you'll find a mint of information that you wouldn't be without. 451 pages, 334 illustrations, five large folding plates. Price \$3.50

LOCOMOTIVE BREAKDOWNS AND THEIR REMEDIES. By GEO. L. FOWLER. Revised by WM. W. WOOD, Air-Brake Instructor. Just issued. Revised pocket edition.

It is out of the question to try and tell you about every subject that is covered in this pocket edition of Locomotive Breakdowns. Just imagine all the common troubles that an engineer may expect to happen some time, and then add all of the unexpected ones, troubles that could occur, but that you have never thought about, and you will find that they are all treated with the very best methods of repair. Walschaert Locomotive Valve Gear Troubles, Electric Headlight Troubles, as well as Questions and Answers on the Air Brake are all included. 293 pages. 8th Revised Edition. Fully illustrated. \$1.50

PRACTICAL INSTRUCTOR AND REFERENCE BOOK FOR LOCOMOTIVE FIREMEN AND ENGINEERS. By CHAS. F. LOCKHART.

An entirely new book on the Locomotive. It appeals to every railroad man, as it tells him how things are done and the right way to do them. Written by a man who has had years of practical experience in locomotive shops and on the road firing and running. The information given in this book cannot be found in any other similar treatise. Eight hundred and fifty-one questions with their answers are included, which will prove specially helpful to those preparing for examination. Practical information on: The Construction and Operation of Locomotives; Breakdowns and their Remedies; Air Brakes and Valve Gears. Rules and Signals are handled in a thorough manner. As a book of reference it cannot be excelled. The book is divided into six parts, as follows: 1. The Fireman's Duties. 2. General Description of the Locomotive. 3. Breakdowns and their Remedies. 4. Air Brakes. 5. Extracts from Standard Rules. 6. Questions for Examination. The 851 questions have been carefully selected and arranged. These cover the examinations required by the different railroads. 368 pages. 88 illustrations. Price \$2.50

PREVENTION OF RAILROAD ACCIDENTS, OR SAFETY IN RAILROADING. By GEORGE BRADSHAW.

This book is a heart-to-heart talk with Railroad Employees, dealing with facts, not theories, and showing the men in the ranks, from every-day experience, how accidents occur and how they may be avoided. The book is illustrated with seventy original photographs and drawings showing the safe and unsafe methods of work. No visionary schemes, no ideal pictures. Just plain facts and Practical Suggestions are given. Every railroad employee who reads the book is a better and safer man to have in railroad service. It gives just the information which will be the means of preventing many injuries and deaths. All railroad employees should procure a copy; read it, and do your part in preventing accidents. 169 pages. Pocket size. Fully illustrated. Price 50 cents

CATALOGUE OF GOOD, PRACTICAL BOOKS

TRAIN RULE EXAMINATIONS MADE EASY. By G. E. COLLINGWOOD.

This is the only practical work on train rules in print. Every detail is covered, and puzzling points are explained in simple, comprehensive language, making it a practical treatise for the Train Dispatcher, Engineman, Trainman, and all others who have to do with the movements of trains. Contains complete and reliable information of the Standard Code of Train Rules for single track. Shows Signals in Colors, as used on the different roads. Explains fully the practical application of train orders, giving a clear and definite understanding of all orders which may be used. The meaning and necessity for certain rules are explained in such a manner that the student may know beyond a doubt the rights conferred under any orders he may receive or the action required by certain rules. As nearly all roads require trainmen to pass regular examinations, a complete set of examination questions, with their answers, are included. These will enable the student to pass the required examinations with credit to himself and the road for which he works. Second Edition revised. 234 pages. Fully illustrated with Train Signals in Colors. Price \$1.50

THE WALSCHAERT AND OTHER MODERN RADIAL VALVE GEARS FOR LOCOMOTIVES. By Wm. W. Wood.

If you would thoroughly understand the Walschaert Valve Gear you should possess a copy of this book, as the author takes the plainest form of a steam engine—a stationary engine in the rough, that will only turn its crank in one direction—and from it builds up—with the reader's help—a modern locomotive equipped with the Walschaert Valve Gear, complete. The points discussed are clearly illustrated; two large folding plates that show the positions of the valves of both inside or outside admission type, as well as the links and other parts of the gear when the crank is at nine different points in its revolution, are especially valuable in making the movement clear. These employ sliding cardboard models which are contained in a pocket in the cover.

The book is divided into five general divisions, as follows: 1. Analysis of the gear. 2. Designing and erecting the gear. 3. Advantages of the gear. 4. Questions and answers relating to the Walschaert Valve Gear. 5. Setting valves with the Walschaert Valve Gear; the three primary types of locomotive valve motion; modern radial valve gears other than the Walschaert; the Hobart All-free Valve and Valve Gear, with questions and answers on breakdowns; the Baker-Pilliod Valve Gear; the Improved Baker-Pilliod Valve Gear, with questions and answers on breakdowns.

The questions with full answers given will be especially valuable to firemen and engineers in preparing for an examination for promotion. 245 pages. Fully illustrated. Third Revised New Edition. Price \$2.50

WESTINGHOUSE E-T AIR-BRAKE INSTRUCTION POCKET BOOK. By Wm. W. Wood, Air-Brake Instructor.

Here is a book for the railroad man, and the man who aims to be one. It is without doubt the only complete work published on the Westinghouse E-T Locomotive Brake Equipment. Written by an Air-Brake Instructor who knows just what is needed. It covers the subject thoroughly. Everything about the New Westinghouse Engine and Tender Brake Equipment, including the standard No. 5 and the Perfected No. 6 style of brake, is treated in detail. Written in plain English and profusely illustrated with Colored Plates, which enable one to trace the flow of pressures throughout the entire equipment. The best book ever published on the Air Brake. Equally good for the beginner and the advanced engineer. Will pass anyone through any examination. It informs and enlightens you on every point. Indispensable to every engineman and trainman.

Contains examination questions and answers on the E-T equipment. Covering what the E-T Brake is. How it should be operated. What to do when defective. Not a question can be asked of the engineman up for promotion, on either the No. 5 or the No. 6 E-T equipment, that is not asked and answered in the book. If you want to thoroughly understand the E-T equipment get a copy of this book. It covers every detail. Makes Air-Brake troubles and examinations easy. Second Revised and Enlarged Edition. Price \$2.50

MACHINE-SHOP PRACTICE

AMERICAN TOOL MAKING AND INTERCHANGEABLE MANUFACTURING. By J. V. WOODWORTH.

A "shoppy" book, containing no theorizing, no problematical or experimental devices, there are no badly proportioned and impossible diagrams, no catalogue cuts, but a valuable collection of drawings and descriptions of devices, the rich fruits of the author's own experience. In its 500-odd pages the one subject only, Tool Making, and whatever relates thereto, is dealt with. The work stands without a rival. It is a complete practical treatise on the art of American Tool Making and system of interchangeable manufacturing as carried on to-day in the United States. In it are described and illustrated all of the different types and classes of small tools, fixtures, devices, and special appliances which are in general use in all machine-manufacturing and metal-working establishments where economy, capacity, and interchangeability in the production of machined metal parts are imperative. The science of jig making is exhaustively discussed, and particular attention is paid to drill jigs, boring, profiling and milling fixtures and other devices in which the parts to be machined are located and fastened within the contrivances. All of the tools, fixtures, and devices illustrated and described have been or are used for the actual production of work, such as parts of drill presses, lathes, patented machinery, typewriters, electrical apparatus, mechanical appliances, brass goods, composition parts, mould products, sheet metal articles, drop-forgings, jewelry, watches, medals, coins, etc. 3rd Edition. 531 pages. Price \$4.50

MACHINE-SHOP ARITHMETIC. By COLVIN-CHENEY.

This is an arithmetic of the things you have to do with daily. It tells you plainly about: how to find areas in figures; how to find surface or volume of balls or spheres; handy ways for calculating; about compound gearing; cutting screw threads on any lathe; drilling for taps; speeds of drills; taps, emery wheels, grindstones, milling cutters, etc.; all about the Metric system with conversion tables; properties of metals; strength of bolts and nuts; decimal equivalent of an inch. All sorts of machine-shop figuring and 1,001 other things, any one of which ought to be worth more than the price of this book to you, and it saves you the trouble of bothering the boss. 7th edition. 131 pages. Price 75 cents

MODERN MACHINE-SHOP CONSTRUCTION, EQUIPMENT AND MANAGEMENT. By OSCAR E. PERRIGO.

The only work published that describes the Modern Shop or Manufacturing Plant from the time the grass is growing on the site intended for it until the finished product is shipped. Just the book needed by those contemplating the erection of modern shop buildings, the rebuilding and reorganization of old ones, or the introduction of Modern Shop Methods, time and cost systems. It is a book written and illustrated by a practical shop man for practical shop men who are too busy to read theories and want facts. It is the most complete all-round book of its kind ever published. 384 pages. 219 original and specially-made illustrations. Revised and Enlarged Edition. Price \$5.00

"SHOP KINKS." By ROBERT GRIMSHAW.

A book of 400 pages and 222 illustrations, being entirely different from any other book on machine-shop practice. Departing from conventional style, the author avoids universal or common shop usage and limits his work to showing special ways of doing things better, more cheaply and more rapidly than usual. As a result the advanced methods of representative establishments of the world are placed at the disposal of the reader. This book shows the proprietor where large savings are possible, and how products may be improved. To the employee it holds out suggestions that, properly applied, will hasten his advancement. No shop can afford to be without it. It bristles with valuable wrinkles and helpful suggestions. It will benefit all, from apprentice to proprietor. 5th edition. Price \$3.00

THREADS AND THREAD-CUTTING. By COLVIN and STABEL.

This clears up many of the mysteries of thread-cutting, such as double and triple threads, internal threads, catching threads, use of hobs, etc. Contains a lot of useful hints and several tables. 4th edition. Price 35 cents

THE WHOLE FIELD OF MECHANICAL MOVEMENTS COVERED BY MR. HISCOX'S TWO BOOKS

We publish two books by Gardner D. Hiscox that will keep you from "inventing" things that have been done before, and suggest ways of doing things that you have not thought of before. Many a man spends time and money, pondering over some mechanical problem, only to learn, after he has solved the problem, that the same thing has been accomplished and put in practice by others long before. Time and money spent in an effort to accomplish what has already been accomplished are time and money LOST. The whole field of mechanics, every known mechanical movement, and practically every device is covered by these two books. If the thing you want has been invented, it is illustrated in them. If it hasn't been invented, then you'll find in them the nearest things to what you want, some movements or devices that will apply in your case, perhaps; or which will give you a key from which to work. No book or set of books ever published is of more real value to the Inventor, Draftsman, or practical Mechanic than the two volumes described below.

MECHANICAL MOVEMENTS, POWERS, AND DEVICES. By GARDNER D. HISCOX.

This is a collection of 1,890 engravings of different mechanical motions and appliances, accompanied by appropriate text, making it a book of great value to the inventor, the draftsman, and to all readers with mechanical tastes. The book is divided into eighteen sections or chapters, in which the subject-matter is classified under the following heads: Mechanical Powers; Transmission of Power; Measurement of Power; Steam Power; Air Power Appliances; Electric Power and Construction; Navigation and Roads; Gearing; Motion and Devices; Controlling Motion; Horological; Mining; Mill and Factory Appliances; Construction and Devices; Drafting Devices; Miscellaneous Devices, etc. 15th edition enlarged. 400 octavo pages. Price . \$4.00

MECHANICAL APPLIANCES, MECHANICAL MOVEMENTS AND NOVELTIES OF CONSTRUCTION. By GARDNER D. HISCOX.

This is a supplementary volume to the one upon mechanical movements. Unlike the first volume, which is more elementary in character, this volume contains illustrations and descriptions of many combinations of motions and of mechanical devices and appliances found in different lines of machinery, each device being shown by a line drawing with a description showing its working parts and the method of operation. From the multitude of devices described and illustrated might be mentioned, in passing, such items as conveyors and elevators, Prony brakes, thermometers, various types of boilers, solar engines, oil-fuel burners, condensers, evaporators, Corliss and other valve gears, governors, gas engines, water motors of various descriptions, airships, motors and dynamos, automobile and motor bicycles, railway lock signals, car couplers, link and gear motions, ball bearings, breech block mechanism for heavy guns, and a large accumulation of others of equal importance. 1,000 specially made engravings. 396 octavo pages. 4th Edition enlarged. Price \$4.00

SHOP PRACTICE FOR HOME MECHANICS. By RAYMOND FRANCIS YATES.

A thoroughly practical and helpful treatment prepared especially for those who have had little or no experience in shop work. The introduction is given over to an elementary explanation of the fundamentals of mechanical science. This is followed by several chapters on the use of small tools and mechanical measuring instruments. Elementary and more advanced lathe work is treated in detail and directions given for the construction of a number of useful shop appliances. Drilling and reaming, heat treatment of tool steel, special lathe operations, pattern making, grinding, and grinding operations, home foundry work, etc., make up the rest of the volume. The book omits nothing that will be of use to those who use tools or to those who wish to learn the use of tools. The great number of clear engravings (over 300) add tremendously to the text matter and to the value of the volume as a visual instructor. Octavo, 320 pages. 309 engravings, Price \$3.00

CATALOGUE OF GOOD, PRACTICAL BOOKS

MACHINE-SHOP TOOLS AND SHOP PRACTICE. By W. H. VANDERVOORT.

A work of 552 pages and 672 illustrations, describing in every detail the construction, operation, and manipulation of both hand and machine tools. Includes chapters on filing, fitting, and scraping surfaces; on drills, reamers, taps, and dies; the lathe and its tools; planers, shapers, and their tools; milling machines and cutters; gear cutters and gear cutting; drilling machines and drill work; grinding machines and their work; hardening and tempering; gearing, belting, and transmission machinery; useful data and tables. 7th Edition. 552 pages. 672 illustrations. Price \$4.50

COMPLETE PRACTICAL MACHINIST. By JOSHUA ROSE.

The new, twentieth revised and enlarged edition is now ready. This is one of the best-known books on machine-shop work, and written for the practical workman in the language of the workshop. It gives full, practical instructions on the use of all kinds of metal-working tools, both hand and machine, and tells how the work should be properly done. It covers lathe work, vise work, drills and drilling, taps and dies, hardening and tempering, the making and use of tools, tool grinding, marking out work, machine tools, etc. No machinist's library is complete without this volume. 20th Edition. 547 pages. 432 illustrations. Price \$3.00

HENLEY'S ENCYCLOPEDIA OF PRACTICAL ENGINEERING AND ALLIED TRADES. Edited by JOSEPH G. HORNER, A.M.I.Mech.E.

This book covers the entire practice of Civil and Mechanical Engineering. The best known experts in all branches of engineering have contributed to these volumes. The Cyclopedea is admirably well adapted to the needs of the beginner and the self-taught practical man, as well as the mechanical engineer, designer, draftsman, shop superintendent, foreman and machinist.

It is a modern treatise in five volumes. Handsomely bound in half morocco, each volume containing nearly 500 pages, with thousands of illustrations, including diagrammatic and sectional drawings with full explanatory details. Five large volumes. Price \$30.00

MODEL MAKING Including Workshop Practice, Design and Construction of Models. Edited by RAYMOND F. YATES. Editor of "Everyday Engineering Magazine."

This book will help you to become a better mechanic. It is full of suggestions for those who like to make things, amateur and professional alike. It has been prepared especially for men with mechanical hobbies. Some may be engineers, machinists, jewelers, pattern makers, office clerks or bank presidents. Men from various walks of life have a peculiar interest in model engineering. MODEL MAKING will be a help and an inspiration to such men. It tells them "how-to-do" and "how-to-make" things in simple, understandable terms. Not only this, it is full of good, clear working drawings and photographs of the models and apparatus described. Each model has been constructed and actually works if it is made according to directions. 379 pages. 300 illustrations. Price \$3.00

ABRASIVES AND ABRASIVE WHEELS. By FRED B. JACOBS.

A new book for everyone interested in abrasives or grinding. A careful reading of the book will not only make mechanics better able to use abrasives intelligently, but it will also tell the shop superintendent of many short cuts and efficiency-increasing kinks. The economic advantages in using large grinding wheels are fully explained, together with many other things that will tend to give the superintendent or workman a keen insight into abrasive engineering. 340 pages. 174 illustrations. This is an indispensable book for every machinist. Price \$3.00

HOME MECHANIC'S WORKSHOP COMPANION. By ANDREW JACKSON, JR.

This treatise includes a compilation of useful suggestions that cannot fail to interest the handy man, and while it is not intended for mechanical experts or scientists, it will prove to be a veritable store of information for anyone who desires to rig up a small shop where odd jobs can be carried on. Price 75 cents

CATALOGUE OF GOOD, PRACTICAL BOOKS

MARINE ENGINEERING

THE NAVAL ARCHITECT'S AND SHIPBUILDER'S POCKETBOOK. Of Formulæ, Rules, and Tables and Marine Engineer's and Surveyor's Handy Book of Reference. By CLEMENT MACKROW and LLOYD WOOLLARD.

The twelfth revised and enlarged edition of this most comprehensive work has just been issued. It is absolutely indispensable to all engaged in the Shipbuilding Industry, as it condenses into a compact form all data and formulæ that are ordinarily required. The book is completely up to date, including among other subjects a section on Aeronautics. 760 pages, limp leather binding. Price \$6.00

MARINE ENGINES AND BOILERS—THEIR DESIGN AND CONSTRUCTION. THE STANDARD BOOK. By DR. G. BAUER, LESLIE S. ROBERTSON and S. BRYAN DONKIN.

In the words of Dr. Bauer, the present work owes its origin to an oft felt want of a condensed treatise embodying the theoretical and practical rules used in designing marine engines and boilers. The fact that the original German work was written by the chief engineer of the famous Vulcan Works, Stettin, is in itself a guarantee that this book is in all respects thoroughly up-to-date, and that it embodies all the information which is necessary for the design and construction of the highest types of marine engines and boilers. It may be said that the motive power which Dr. Bauer has placed in the fast German liners that have been turned out of late years from the Stettin Works represent the very best practice in marine engineering of the present day. The work is clearly written, thoroughly systematic, theoretically sound; while the character of the plans, drawings, tables, and statistics is without reproach. The illustrations are careful reproductions from actual working drawings, with some well-executed photographic views of completed engines and boilers. Fifth impression. 744 pages. 550 illustrations, and numerous tables. Cloth. Price . . . \$10.00

MANUAL TRAINING

ECONOMICS OF MANUAL TRAINING. By LOUIS ROUILLON.

The only book published that gives just the information needed by all interested in Manual Training, regarding Buildings, Equipment, and Supplies. Shows exactly what is needed for all grades of the work from the Kindergarten to the High and Normal School. Gives itemized lists of everything used in Manual Training Work and tells just what it ought to cost. Also shows where to buy supplies, etc. Contains 174 pages, and is fully illustrated. 2d edition. Price \$2.00

MOTOR BOATS

MOTOR BOATS AND BOAT MOTORS. By VICTOR W. PAGÉ AND A. C. LEITCH.

All who are interested in motor boats, either as owners, builders or repairmen, will find this latest work a most comprehensive treatise on the design, construction, operation and repair of motor boats and their power plants. It is really two complete books in one cover as it consists of two parts, each complete in itself. Part One deals with THE HULL AND ITS FITTINGS, Part Two considers THE POWER PLANT AND ITS AUXILIARIES. A valuable feature of this book is the complete set of dimensioned working drawings detailing the construction of five different types of boats ranging from a 16-foot shallow draft, tunnel stern general utility craft to a 25-foot cabin cruiser. These plans are by A. C. Leitch, a practical boat builder and expert naval architect, and are complete in every particular. Full instructions are given for the selection of a power plant and its installation in the hull. Valuable advice is included on boat and engine operation and latest designs of motors are described and illustrated. The instructions for overhauling boat and engine are worth many times the small cost of the book. It is a comprehensive work of reference for all interested in motor boating in any of its phases. Octavo. Cloth. 372 illustrations. 524 pages. Price \$4.00.

MOTORCYCLES

MOTORCYCLES AND SIDE CARS, THEIR CONSTRUCTION, MANAGEMENT AND REPAIR. By VICTOR W. PAGÉ, M.E.

The only complete work published for the motorcyclist and repairman. Describes fully all leading types of machines, their design, construction, maintenance, operation and repair. This treatise outlines fully the operation of two- and four-cycle power plants and all ignition, carburetion and lubrication systems in detail. Describes all representative types of free engine clutches, variable speed gears and power transmission systems. Gives complete instructions for operating and repairing all types. Considers fully electric self-starting and lighting systems, all types of spring frames and spring forks and shows leading control methods. For those desiring technical information a complete series of tables and many formulæ to assist in designing are included. The work tells how to figure power needed to climb grades, overcome air resistance and attain high speeds. It shows how to select gear ratios for various weights and powers, how to figure braking efficiency required, gives sizes of belts and chains to transmit power safely, and shows how to design sprockets, belt pulleys, etc. This work also includes complete formulæ for figuring horse-power, shows how dynamometer tests are made, defines relative efficiency of air- and water-cooled engines, plain and anti-friction bearings and many other data of a practical, helpful, engineering nature. Remember that you get this information in addition to the practical description and instructions which alone are worth several times the price of the book. 2nd Edition Revised and Enlarged. 693 pages. 371 specially made illustrations. Cloth. Price \$3.00

WHAT IS SAID OF THIS BOOK:

"Here is a book that should be in the cycle repairer's kit."—*American Blacksmith.*
"The best way for any rider to thoroughly understand his machine, is to get a copy of this book; it is worth many times its price."—*Pacific Motorcyclist.*

PATTERN MAKING

PRACTICAL PATTERN MAKING. By F. W. BARROWS.

This book, now in its second edition, is a comprehensive and entirely practical treatise on the subject of pattern making, illustrating pattern work in both wood and metal, and with definite instructions on the use of plaster of Paris in the trade. It gives specific and detailed descriptions of the materials used by pattern makers and describes the tools, both those for the bench and the more interesting machine tools; having complete chapters on the Lathe, the Circular Saw, and the Band Saw. It gives many examples of pattern work, each one fully illustrated and explained with much detail. These examples, in their great variety, offer much that will be found of interest to all pattern makers, and especially to the younger ones, who are seeking information on the more advanced branches of their trade.

In this second edition of the work will be found much that is new, even to those who have long practiced this exacting trade. In the description of patterns as adapted to the Moulding Machine many difficulties which have long prevented the rapid and economical production of castings are overcome; and this great, new branch of the trade is given much space. Stripping plate and stool plate work and the less expensive vibrator, or rapping plate work, are all explained in detail.

Plain, everyday rules for lessening the cost of patterns, with a complete system of cost keeping, a detailed method of marking, applicable to all branches of the trade, with complete information showing what the pattern is, its specific title, its cost, date of production, material of which it is made, the number of pieces and core-boxes, and its location in the pattern safe, all condensed into a most complete card record, with cross index.

The book closes with an original and practical method for the inventory and valuation of patterns. 2nd Edition. Containing nearly 350 pages and 170 illustrations. Price \$2.50

CATALOGUE OF GOOD, PRACTICAL BOOKS

PERFUMERY

PERFUMES AND COSMETICS, THEIR PRÉPARATION AND MANUFACTURE. By G. W. ASKINSON, Perfumer.

A comprehensive treatise, in which there has been nothing omitted that could be of value to the perfumer or manufacturer of toilet preparations. Complete directions for making handkerchief perfumes, smelling-salts, sachets, fumigating pastilles; preparations for the care of the skin, the mouth, the hair, cosmetics, hair dyes and other toilet articles are given, also a detailed description of aromatic substances; their nature, tests of purity, and wholesale manufacture, including a chapter on synthetic products, with formulas for their use. A book of general, as well as professional interest, meeting the wants not only of the druggist and perfume manufacturer, but also of the general public. Fourth Edition much enlarged and brought up-to-date. Nearly 400 pages, illustrated. Price \$5.00

WHAT IS SAID OF THIS BOOK:

- “The most satisfactory work on the subject of Perfumery that we have ever seen.
- “We feel safe in saying that here is a book on Perfumery that will not disappoint you, for it has practical and excellent formulæ that are within your ability to prepare readily.
- “We recommend the volume as worthy of confidence, and say that no purchaser will be disappointed in securing from its pages good value for its cost, and a large dividend on the same, even if he should use but one per cent of its working formulæ. There is money in it for every user of its information.”—*Pharmaceutical Record.*

PLUMBING

MECHANICAL DRAWING FOR PLUMBERS. By R. M. STARBUCK.

A concise, comprehensive and practical treatise on the subject of mechanical drawing in its various modern applications to the work of all who are in any way connected with the plumbing trade. Nothing will so help the plumber in estimating and in explaining work to customers and workmen as a knowledge of drawing, and to the workman it is of inestimable value if he is to rise above his position to positions of greater responsibility. Among the chapters contained are: 1. Value to plumber of knowledge of drawing; tools required and their use; common views needed in mechanical drawing. 2. Perspective versus mechanical drawing in showing plumbing construction. 3. Correct and incorrect methods in plumbing drawing; plan and elevation explained. 4. Floor and cellar plans and elevation; scale drawings; use of triangles. 5. Use of triangles; drawing of fittings, traps, etc. 6. Drawing plumbing elevations and fittings. 7. Instructions in drawing plumbing elevations. 8. The drawing of plumbing fixtures; scale drawings. 9. Drawings of fixtures and fittings. 10. Inking of drawings. 11. Shading of drawings. 12. Shading of drawings. 13. Sectional drawings; drawing of threads. 14. Plumbing elevations from architect's plan. 15. Elevations of separate parts of the plumbing system. 16. Elevations from the architect's plans. 17. Drawings of detail plumbing connections. 18. Architect's plans and plumbing elevations of residence. 19. Plumbing elevations of residence (continued); plumbing plans for cottage. 20. Plumbing elevations; roof connections. 21. Plans and plumbing elevations for six-flat building. 22. Drawing of various parts of the plumbing system; use of scales. 23. Use of architect's scales. 24. Special features in the illustrations of country plumbing. 25. Drawing of wrought-iron piping, valves, radiators, coils, etc. 26. Drawing of piping to illustrate heating systems. 150 illustrations. Price \$2.00

CATALOGUE OF GOOD, PRACTICAL BOOKS

MODERN PLUMBING ILLUSTRATED. By R. M. STARBUCK.

This book represents the highest standard of plumbing work. It has been adopted and used as a reference book by the United States Government, in its sanitary work in Cuba, Porto Rico, and the Philippines, and by the principal Boards of Health of the United States and Canada.

It gives connections, sizes and working data for all fixtures and groups of fixtures. It is helpful to the master plumber in demonstrating to his customers and in figuring work. It gives the mechanic and student quick and easy access to the best modern plumbing practice. Suggestions for estimating plumbing construction are contained in its pages. This book represents, in a word, the latest and best up-to-date practice and should be in the hands of every architect, sanitary engineer and plumber who wishes to keep himself up to the minute on this important feature of construction. Contains following chapters, each illustrated with a full-page plate: Kitchen sink, laundry tubs, vegetable wash sink; lavatories, pantry sinks, contents of marble slabs; bath tub, foot and sitz bath, shower bath; water closets, venting of water closets; low-down water closets, water closets operated by flush valves, water closet range; slop sink, urinals, the bidet; hotel and restaurant sink, grease trap; refrigerators, safe wastes, laundry waste, lines of refrigerators, bar sinks, soda fountain sinks; horse stall, frost-proof water closets; connections for S traps, venting; connections for drum traps; soil pipe connections; supporting of soil pipe; main trap and fresh air inlet; floor drains and cellar drains, subsoil drainage; water closets and floor connections; local venting; connections for bath rooms; connections for bath rooms, continued; connections for bath rooms, continued; connections for bath rooms, continued; examples of poor practice; roughing work ready for test; testing of plumbing system; method of continuous venting; continuous venting for two-floor work; continuous venting for two lines of fixtures on three or more floors; continuous venting of water closets; plumbing for cottage house; construction for cellar piping; plumbing for residence, use of special fittings; plumbing for two-flat house; plumbing for apartment building, plumbing for double apartment building; plumbing for office building; plumbing for public toilet rooms; plumbing for public toilet rooms, continued; plumbing for bath establishment; plumbing for engine house, factory; plumbing; automatic flushing, for schools, factories, etc.; use of flushing valves; urinals for public toilet rooms; the Durham system, the destruction of pipes by electrolysis; construction of work without use of lead; automatic sewage lift; automatic sump tank; country plumbing; construction of cesspools; septic tank and automatic sewage siphon; country plumbing; water supply for country house; thawing of water mains and service by electricity; double boilers; hot water supply of large buildings; automatic control of hot water tank; suggestion for estimating plumbing construction. 407 octavo pages, fully illustrated by 58 full-page engravings. Third, revised and enlarged edition just issued. Price . \$5.00

STANDARD PRACTICAL PLUMBING. By R. M. STARBUCK.

A complete practical treatise of 450 pages covering the subject of Modern Plumbing in all its branches, a large amount of space being devoted to a very complete and practical treatment of the subject of Hot Water Supply and Circulation and Range Boiler Work. Its thirty chapters include about every phase of the subject one can think of, making it an indispensable work to the master plumber, the journeyman plumber, and the apprentice plumber, containing chapters on: the plumber's tools; wiping solder; composition and use; joint wiping; lead work; traps; siphonage of traps; venting; continuous venting; house sewer and sewer connections; house drain; soil piping, roughing; main trap and fresh air inlet; floor, yard, cellar drains, rain leaders, etc.; fixture wastes; water closets; ventilation; improved plumbing connections; residence plumbing; plumbing for hotels, schools, factories, stables, etc.; modern country plumbing; filtration of sewage and water supply; hot and cold supply; range boilers; circulation; circulating pipes; range boiler problems; hot water for large buildings; water lift and its use; multiple connections for hot water boilers; heating of radiation by supply system; theory for the plumber; drawing for the plumber. Fully illustrated by 347 engravings. Price \$3.50

RECIPE BOOK

HENLEY'S TWENTIETH CENTURY BOOK OF RECIPES, FORMULAS AND PROCESSES. Edited by GARDNER D. HISCOX.

The most valuable Techno-chemical Formula Book published, including over 10,000 selected scientific, chemical, technological, and practical recipes and processes.

This is the most complete Book of Formulas ever published, giving thousands of recipes for the manufacture of valuable articles for everyday use. Hints, Helps, Practical Ideas, and Secret Processes are revealed within its pages. It covers every branch of the useful arts and tells thousands of ways of making money, and is just the book everyone should have at his command.

Modern in its treatment of every subject that properly falls within its scope, the book may truthfully be said to present the very latest formulas to be found in the arts and industries, and to retain those processes which long experience has proven worthy of a permanent record. To present here even a limited number of the subjects which find a place in this valuable work would be difficult. Suffice to say that in its pages will be found matter of intense interest and immeasurably practical value to the scientific amateur and to him who wishes to obtain a knowledge of the many processes used in the arts, trades and manufacture, a knowledge which will render his pursuits more instructive and remunerative. Serving as a reference book to the small and large manufacturer and supplying intelligent seekers with the information necessary to conduct a process, the work will be found of inestimable worth to the Metallurgist, the Photographer, the Perfumer, the Painter, the Manufacturer of Glues, Pastes, Cements, and Mucilages, the Compounder of Alloys, the Cook, the Physician, the Druggist, the Electrician, the Brewer, the Engineer, the Foundryman, the Machinist, the Potter, the Tanner, the Confectioner, the Chiropodist, the Manicure, the Manufacturer of Chemical Novelties and Toilet Preparations, the Dyer, the Electroplater, the Enameler, the Engraver, the Provisioner, the Glass Worker, the Goldbeater, the Watchmaker, the Jeweler, the Hat Maker, the Ink Manufacturer, the Optician, the Farmer, the Dairyman, the Paper Maker, the Wood and Metal Worker, the Chandler and Soap Maker, the Veterinary Surgeon, and the Technologist in general.

A mine of information, and up-to-date in every respect. A book which will prove of value to EVERYONE, as it covers every branch of the Useful Arts. Every home needs this book; every office, every factory, every store, every public and private enterprise — EVERYWHERE — should have a copy. 800 pages. Cloth Bound. Price \$4.00

WHAT IS SAID OF THIS BOOK:

"Your Twentieth Century Book of Recipes, Formulas, and Processes duly received. I am glad to have a copy of it, and if I could not replace it, money couldn't buy it. It is the best thing of the sort I ever saw." (Signed) M. E. TRUX, Sparta, Wis.

"There are few persons who would not be able to find in the book some single formula that would repay several times the cost of the book."—*Merchants' Record and Show Window.*

"I purchased your book 'Henley's Twentieth Century Book of Recipes, Formulas and Processes' about a year ago and it is worth its weight in gold."—WM. H. MURRAY, Bennington, Vt.

"THE BOOK WORTH THREE HUNDRED DOLLARS"

"On close examination of your 'Twentieth Century Receipt Book,' I find it to be a very valuable and useful book with the very best of practical information obtainable. The price of the book, \$4.00, is very small in comparison to the benefits which one can obtain from it. I consider the book worth fully three hundred dollars to anyone." —DR. A. C. SPETTS, New York.

"ONE OF THE WORLD'S MOST USEFUL BOOKS"

"Some time ago, I got one of your 'Twentieth Century Books of Formulas' and have made my living from it ever since. I am alone since my husband's death with two small children to care for and am trying so hard to support them. I have customers who take from me Toilet Articles I put up, following directions given in the book, and I have found every one of them to be fine."—MRS. J. H. MCMAKEN, West Toledo, Ohio.

CATALOGUE OF GOOD, PRACTICAL BOOKS

RUBBER

RUBBER HAND STAMPS AND THE MANIPULATION OF INDIA RUBBER.

By T. O'CONNOR SLOANE.

This book gives full details on all points, treating in a concise and simple manner the elements of nearly everything it is necessary to understand for a commencement in any branch of the India Rubber Manufacture. The making of all kinds of Rubber Hand Stamps, Small Articles of India Rubber, U. S. Government Composition, Dating Hand Stamps, the Manipulation of Sheet Rubber, Toy Balloons, India Rubber Solutions, Cements, Blackings, Renovating Varnish, and Treatment for India Rubber Shoes, etc.; the Hektograph Stamp Inks, and Miscellaneous Notes, with a Short Account of the Discovery, Collection and Manufacture of India Rubber, are set forth in a manner designed to be readily understood, the explanations being plain and simple. Including a chapter on Rubber Tire Making and Vulcanizing; also a chapter on the uses of rubber in Surgery and Dentistry. Third revised and enlarged edition. 175 pages. Illustrated \$1.50

SAWS

SAW FILING AND MANAGEMENT OF SAWS. By ROBERT GRIMSHAW.

A practical hand-book on filing, gumming, swaging, hammering, and the brazing of hand saws, the speed, work, and power to run circular saws, etc. A handy book for those who have charge of saws, or for those mechanics who do their own filing, as it deals with the proper shape and pitches of saw teeth of all kinds and gives many useful hints and rules for gumming, setting, and filing, and is a practical aid to those who use saws for any purpose. Complete tables of proper shape, pitch, and saw teeth as well as sizes and number of teeth of various saws are included. Fourth edition, revised and enlarged. Illustrated. Price \$1.50

SCREW CUTTING

THREADS AND THREAD-CUTTING. By COLVIN and STABLE.

This clears up many of the mysteries of thread-cutting, such as double and triple threads, internal threads, catching threads, use of hobs, etc. Contains a lot of useful hints and several tables. Fourth Edition. Price 35 cents

STEAM ENGINEERING

MODERN STEAM ENGINEERING IN THEORY AND PRACTICE. By

GARDNER D. HISCOX.

This is a complete and practical work issued for Stationary Engineers and Firemen, dealing with the care and management of boilers, engines, pumps, superheated steam, refrigerating machinery, dynamos, motors, elevators, air compressors, and all other branches with which the modern engineer must be familiar. Nearly 200 questions with their answers on steam and electrical engineering, likely to be asked by the Examining Board, are included.

Among the chapters are: Historical: steam and its properties; appliances for the generation of steam; types of boilers; chimney and its work; heat economy of the feed water; steam pumps and their work; incrustation and its work; steam above atmospheric pressure; flow of steam from nozzles; superheated steam and its work; adiabatic expansion of steam; indicator and its work; steam engine proportions; slide valve engines and valve motion; Corliss engine and its valve gear; compound engine and its theory; triple and multiple expansion engine; steam turbine; refrigeration; elevators and their management; cost of power; steam engine troubles; electric power and electric plants. 487 pages. 405 engravings. 3d Edition. . . . \$3.50

CATALOGUE OF GOOD, PRACTICAL BOOKS

AMERICAN STATIONARY ENGINEERING. By W. E. CRANE.

This book begins at the boiler room and takes in the whole power plant. A plain talk on every-day work about engines, boilers, and their accessories. It is not intended to be scientific or mathematical. All formulas are in simple form so that anyone understanding plain arithmetic can readily understand any of them. The author has made this the most practical book in print; has given the results of his years of experience, and has included about all that has to do with an engine room or a power plant. You are not left to guess at a single point. You are shown clearly what to expect under the various conditions; how to secure the best results; ways of preventing "shut downs" and repairs; in short, all that goes to make up the requirements of a good engineer, capable of taking charge of a plant. It's plain enough for practical men and yet of value to those high in the profession.

A partial list of contents is: The boiler room, cleaning boilers, firing, feeding; pumps; inspection and repair; chimneys, sizes and cost; piping; mason work; foundations; testing cement; pile driving; engines, slow and high speed; valves; valve setting; Corliss engines, setting valves, single and double eccentric; air pumps and condensers; different types of condensers; water needed; lining up; pounds; pins not square in crosshead or crank; engineers' tools; pistons and piston rings; bearing metal; hardened copper; drip pipes from cylinder jackets; belts, how made, care of; oils; greases; testing lubricants; rules and tables, including steam tables; areas of segments; squares and square roots; cubes and cube root; areas and circumferences of circles. Notes on: Brick work; explosions; pumps; pump valves; heaters, economizers; safety valves; lap, lead, and clearance. Has a complete examination for a license, etc., etc. Third edition. 311 pages. 131 Illustrations. Price. . . . \$2.50

ENGINE RUNNER'S CATECHISM. By ROBERT GRIMSHAW.

A practical treatise for the stationary engineer, telling how to erect, adjust, and run the principal steam engines in use in the United States. Describing the principal features of various special and well-known makes of engines: Temper Cut-off, Shipping and Receiving Foundations, Erecting and Starting, Valve Setting, Care and Use, Emergencies, Erecting and Adjusting Special Engines.

The questions asked throughout the catechism are plain and to the point, and the answers are given in such simple language as to be readily understood by anyone. All the instructions given are complete and up-to-date; and they are written in a popular style, without any technicalities or mathematical formulæ. The work is of a handy size for the pocket, clearly and well printed, nicely bound, and profusely illustrated.

To young engineers this catechism will be of great value, especially to those who may be preparing to go forward to be examined for certificates of competency; and to engineers generally it will be of no little service, as they will find in this volume more really practical and useful information than is to be found anywhere else within a like compass. 387 pages. Seventh edition. Price \$2.00

HORSE-POWER CHART.

Shows the horse-power of any stationary engine without calculation. No matter what the cylinder diameter of stroke, the steam pressure of cut-off, the revolutions, or whether condensing or non-condensing, it's all there. Easy to use, accurate, and saves time and calculations. Especially useful to engineers and designers. 50 cents

STEAM ENGINE CATECHISM. By ROBERT GRIMSHAW.

This unique volume of 413 pages is not only a catechism on the question and answer principle, but it contains formulas and worked-out answers for all the Steam problems that appertain to the operation and management of the Steam Engine. Illustrations of various valves and valve gear with their principles of operation are given. Thirty-four Tables that are indispensable to every engineer and fireman that wishes to be progressive and is ambitious to become master of his calling are within its pages. It is a most valuable instructor in the service of Steam Engineering. Leading engineers have recommended it as a valuable educator for the beginner as well as a reference book for the engineer. It is thoroughly indexed for every detail. Every essential question on the Steam Engine with its answer is contained in this valuable work. Sixteenth edition. Price \$2.00

CATALOGUE OF GOOD, PRACTICAL BOOKS

STEAM ENGINEER'S ARITHMETIC. By COLVIN-CHENEY.

A practical pocket-book for the steam engineer. Shows how to work the problems of the engine room and shows "why." Tells how to figure horse-power of engines and boilers; area of boilers; has tables of areas and circumferences; steam tables; has a dictionary of engineering terms. Puts you on to all of the little kinks in figuring whatever there is to figure around a power plant. Tells you about the heat unit; absolute zero; adiabatic expansion; duty of engines; factor of safety; and a thousand and one other things; and everything is plain and simple—not the hardest way to figure, but the easiest. Second Edition. 75 cents

STEAM ENGINE TROUBLES. By H. HAMKENS.

It is safe to say that no book has ever been published which gives the practical engineer such valuable and comprehensive information on steam engine design and troubles.

Not only does it describe the troubles the principal parts of steam engines are subject to; it contrasts good design with bad, points out the most suitable material for certain parts, and the most approved construction of the same; it gives directions for correcting existing evils by following which *breakdowns* and *costly accidents* can be avoided. Just look into the nature of the information this book gives on the following subjects. There are descriptions of cylinders, valves, pistons, frames, pillow blocks and other bearings, connecting rods, wristplates, dashpots, reachrods, valve gears, governors, piping, throttle and emergency valves, safety stops, fly-wheels, oilers, etc. If there is any trouble with these parts, the book gives you the reasons and tells how to remedy them.

The principal considerations in the building of foundations are given with the size, area and weight required for the same, also the setting of templets and lining up, and a complete account of the *erection* and "*breaking in*" of new engines in the language of the man on the job.

Contains special chapters on: I. Cylinders. II. Valves. III. Piping and Separators. IV. Throttle and Emergency Valves. V. Pistons. VI. Frames. VII. Bearings. VIII. Connecting Rods. IX. Hookrods. X. Dashpots. XI. Governors. XII. Releasing Gears. XIII. Wristplates and Valve Motions. XIV. Rodends and Bonnets. XV. Oilers. XVI. Receivers. XVII. Foundations. XVIII. Erection. XIX. Valve-Setting. XX. Operation. 284 pages. 276 illustrations. Price \$2.50

STEAM HEATING AND VENTILATION

PRACTICAL STEAM, HOT-WATER HEATING AND VENTILATION. By A. G. KING.

This book is the standard and latest work published on the subject and has been prepared for the use of all engaged in the business of steam, hot-water heating, and ventilation. It is an original and exhaustive work. Tells how to get heating contracts, how to install heating and ventilating apparatus, the best business methods to be used, with "Tricks of the Trade" for shop use. Rules and data for estimating radiation and cost and such tables and information as make it an indispensable work for everyone interested in steam, hot-water heating, and ventilation. It describes all the principal systems of steam, hot-water, vacuum, vapor, and vacuum-vapor heating, together with the new accelerated systems of hot-water circulation, including chapters on up-to-date methods of ventilation and the fan or blower system of heating and ventilation. Containing chapters on: I. Introduction. II. Heat. III. Evolution of artificial heating apparatus. IV. Boiler surface and settings. V. The chimney flue. VI. Pipe and fittings. VII. Valves, various kinds. VIII. Forms of radiating surfaces. IX. Locating of radiating surfaces. X. Estimating radiation. XI. Steam-heating apparatus. XII. Exhaust-steam heating. XIII. Hot-water heating. XIV. Pressure systems of hot-water work. XV. Hot-water appliances. XVI. Greenhouse heating. XVII. Vacuum vapor and vacuum exhaust heating. XVIII. Miscellaneous heating. XIX. Radiator and pipe connections. XX. Ventilation. XXI. Mechanical ventilation and hot-blast heating. XXII. Steam appliances. XXIII. District heating. XXIV. Pipe and boiler covering. XXV. Temperature regulation and heat control. XXVI. Business methods. XXVII. Miscellaneous. XXVIII. Rules, tables, and useful information. 402 pages. 300 detailed engravings. Third Edition—Revised. Price \$3.50

CATALOGUE OF GOOD, PRACTICAL BOOKS

500 PLAIN ANSWERS TO DIRECT QUESTIONS ON STEAM, HOT-WATER, VAPOR AND VACUUM HEATING PRACTICE. By ALFRED G. KING.

This work, just off the press, is arranged in question and answer form; it is intended as a guide and text-book for the younger, inexperienced fitter and as a reference book for all fitters. This book tells "how" and also tells "why." No work of its kind has ever been published. It answers all the questions regarding each method or system that would be asked by the steam fitter or heating contractor, and may be used as a text or reference book, and for examination questions by Trade Schools or Steam Fitters' Associations. Rules, data, tables and descriptive methods are given, together with much other detailed information of daily practical use to those engaged in or interested in the various methods of heating. Valuable to those preparing for examinations. Answers every question asked relating to modern Steam, Hot-Water, Vapor and Vacuum Heating. Among the contents are: The Theory and Laws of Heat. Methods of Heating. Chimneys and Flues. Boilers for Heating. Boiler Trimmings and Settings. Radiation. Steam Heating. Boiler, Radiator and Pipe Connections for Steam Heating. Hot Water Heating. The Two-Pipe Gravity System of Hot Water Heating. The Circuit System of Hot Water Heating. The Overhead System of Hot Water Heating. Boiler, Radiator and Pipe Connections for Gravity Systems of Hot Water Heating. Accelerated Hot Water Heating. Expansion Tank Connections. Domestic Hot Water Heating. Valves and Air Valves. Vacuum Vapor and Vacuo-Vapor Heating. Mechanical Systems of Vacuum Heating. Non-Mechanical Vacuum Systems. Vapor Systems. Atmospheric and Modulating Systems. Heating Greenhouses. Information, Rules and Tables. 214 pages, 127 illustrations. Octavo. Cloth. Price \$2.00

STEEL

STEEL: ITS SELECTION, ANNEALING, HARDENING, AND TEMPERING.

By E. R. MARKHAM.

This book tells how to select, and how to work, temper, harden, and anneal steel for everything on earth. It doesn't tell how to temper one class of tools and then leave the treatment of another kind of tool to your imagination and judgment, but it gives careful instructions for every detail of every tool, whether it be a tap, a reamer or just a screw-driver. It tells about the tempering of small watch springs, the hardening of cutlery, and the annealing of dies. In fact, there isn't a thing that a steel worker would want to know that isn't included. It is the standard book on selecting, hardening, and tempering all grades of steel. Among the chapter headings might be mentioned the following subjects: Introduction; the workman; steel; methods of heating; heating tool steel; forging; annealing; hardening baths; baths for hardening; hardening steel; drawing the temper after hardening; examples of hardening; pack hardening; case hardening; spring tempering; making tools of machine steel; special steels; steel for various tools, causes of trouble; high speed steels, etc. 400 pages. Very fully illustrated. Fourth Edition. Price \$3.00

HARDENING, TEMPERING, ANNEALING, AND FORGING OF STEEL. INCLUDING HEAT TREATMENT OF MODERN ALLOY STEELS.

By J. V. WOODWORTH.

A new work treating in a clear, concise manner all modern processes for the heating, annealing, forging, welding, hardening, and tempering of high and low grade steel, making it a book of great practical value to the metal-working mechanic in general, with special directions for the successful hardening and tempering of all steel tools used in the arts, including milling cutters, taps, thread dies, reamers, both solid and shell, hollow mills, punches and dies, and all kinds of sheet metal working tools, shear blades, saws, fine cutlery, and metal cutting tools of all description, as well as for all implements of steel both large and small. In this work the simplest and most satisfactory hardening and tempering processes are given. The uses to which the leading brands of steel may be adapted are concisely presented, and their treatment for working under different conditions explained, also the special methods for the hardening and tempering of special brands. A chapter devoted to the different processes for case-hardening is also included, and special reference made to the adaptation of machinery steel for tools of various kinds. 5th Edition. 321 pages. 201 illustrations. Price \$3.00

TRACTORS

MODERN GAS TRACTOR: ITS CONSTRUCTION; UTILITY, OPERATION AND REPAIR. By VICTOR W. PAGE.

An enlarged and revised edition that treats exclusively on the design and construction of farm tractors and tractor power plants, and gives complete instructions on their care, operation and repair. All types and sizes of gasoline, kerosene and oil tractors are described, and every phase of traction engineering practice fully covered. Invaluable to all desiring reliable information on gas motor propelled traction engines and their use. All new 1921 types of tractors are described and complete instructions are given for their use on the farm. The chapter on engine repairing has been greatly enlarged and complete and detailed instructions are now given for repairing well-known and widely used tractor power plants, numerous new forms of which are described. Valuable information compiled by Government experts on laying out fields for tractor plowing and numerous practical suggestions for hitches so all types of agricultural machinery can be operated by tractors, are outlined. The chapter on tractor construction and upkeep has been more than doubled in size. Over 100 new illustrations have been added and the book greatly enlarged. Full instructions are now given for using kerosene and distillate as fuel. The 1921 edition is 50 per cent larger than the second edition and is more than ever the acknowledged authority on farm tractors and their many uses. 5¼ x 7½ inches. Cloth, nearly 700 pages and about 300 illustrations, 3 folding plates. Price \$3.00

WELDING

MODERN WELDING METHODS. By VICTOR W. PAGE.

One of the most instructive books on all methods of joining metals yet published for the mechanic and practical man. It considers in detail oxy-acetylene welding, the Thermit process and all classes of electric arc and resistance welding. It shows all the apparatus needed and how to use it. It considers the production of welding gases, construction and operation of welding and cutting torches of all kinds. It details the latest approved methods of preparing work for welding. All forms of gas and electric welding machines are described and complete instructions are given for installing electric spot and butt welders. Cost data are given and all methods of doing the work economically are described. It includes instructions for forge and dip brazing and manufacture of hard solders and spelters. It shows and explains soft soldering processes and tells how to make solders for any use. Complete instructions are given for soldering aluminum and authoritative formulas for aluminum solders are included. 292 pages. 200 illustrations. 1921 edition. Price . . . \$3.00

AUTOMOBILE WELDING WITH THE OXY-ACETYLENE FLAME. By M. KEITH DUNHAM.

Explains in a simple manner apparatus to be used, its care, and how to construct necessary shop equipment. Proceeds then to the actual welding of all automobile parts, in a manner understandable by everyone. Gives principles never to be forgotten. This book is of utmost value, since the perplexing problems arising when metal is heated to a melting point are fully explained and the proper methods to overcome them shown. 167 pages. Fully illustrated. Price \$1.50

DATE DUE

MAR 19 1990			
SEP - 1 1993			
JAN 22 2004			

UNIVERSITY PRODUCTS, INC. #859-5503

142757

BOSTON COLLEGE



3 9031 01460939 0

BOSTON COLLEGE LIBRARY
UNIVERSITY HEIGHTS
CHESTNUT HILL, MASS.

Books may be kept for two weeks and may be renewed for the same period, unless reserved.

Two cents a day is charged for each book kept overtime.

If you cannot find what you want, ask the Librarian who will be glad to help you.

The borrower is responsible for books drawn on his card and for all fines accruing on the same.



